

# LOBSTER Cordless Rivet Nut Setter N1B1 Easy Guide

Original Easy Guide

Thank you for purchasing the cordless rivet nut setter (hereinafter referred to as this machine).

## About the instruction manual

- An instruction manual is not included with this machine. When using the product, be sure to read the instruction manual published on the Lobtex Co., Ltd. website together with the Easy Guide (this document) to ensure proper use.
- Please access the instruction manual from the URL below on your computer/smartphone and read it together with this document.  
<https://www.lobtex.co.jp/english/products/tabid/153/pdId/E-N1B1/catid/108/Default.aspx>
- After reading this manual, please keep it in a safe place with this machine.



For smartphone

## Introduction

- This machine is a dedicated tool for crimping and fastening blind rivet nuts (hereafter referred to as rivet nuts). It is not designed, manufactured, or sold for any other purposes.
- Please use rivet nuts whose specifications and strength have been thoroughly designed and considered by the customer.

## 1 Easy Guide (this document), Safety Guide and Instruction Manual

Instructions for using this machine are divided into the Easy Guide (this document), Safety Guide, and Instruction Manual. Depending on the information you need, refer to the Easy Guide (this document), Safety Guide, or Instruction Manual.

Main contents described in the Easy Guide (this document)

- Name of each part
- Set contents
- Initial setting method
- Serial No.

Main contents of the Safety Guide

- General safety warnings for power tools
- Safety warnings/cautions for cordless rivet nut setter

Main contents of the Instruction Manual

- Safety precautions
- Names of each part
- Specifications
- Preparation before use
- Adjustment method
- Work procedure
- Error display list
- Output setting table for each rivet nut
- Troubleshooting
- How to order parts

## 2 Important Notice

- Before using this machine, please read this manual and the instruction manual/safety guide carefully. In addition, please follow the instructions in this manual when handling this machine and when replacing accessories and parts.
- If you have any questions about this manual and the instruction manual/safety guide, please contact the store where you purchased it or the Lobtex Co., Ltd. (hereinafter referred to as our company) call center.
- It is not possible to predict all the dangers that may be mixed with this machine and to include them in this manual and the instruction manual/safety guide. When using this machine, please pay careful attention to safety measures in addition to what is written in this manual and the instruction manual/safety guide.
- This manual and the instruction manual/safety guide are written in Japanese as the original language. Please fully understand the contents of this manual and the instruction manual/safety guide at your own responsibility.
- The copyright of this manual and the instruction manual/safety guide is owned by our company. It is prohibited to publish, copy, reproduce, or translate the contents of this manual and the instruction manual/safety guide into another language without permission.

## 3 Disclaimer

- We do not compensate for direct or indirect injury or lost profits caused by misuse, abuse or unauthorized modification of this unit, nor do we guarantee the strength of the blind nuts themselves.
- We are not liable for any damage or injury caused by modifications made without our written approval.
- We are not liable for any damage or injury caused by the use of parts other than the recommended parts.

LOBTEX CO.,LTD.

Call center Tel: +81-72-980-1111 Fax: +81-72-980-1166

12-8 Shijo-cho, Higashi-Osaka City, Osaka 579-8053, Japan

Website <https://www.lobtex.co.jp/>  
No.NEN1B1SK2A31

## Names of components

### Machine body (N1B1)

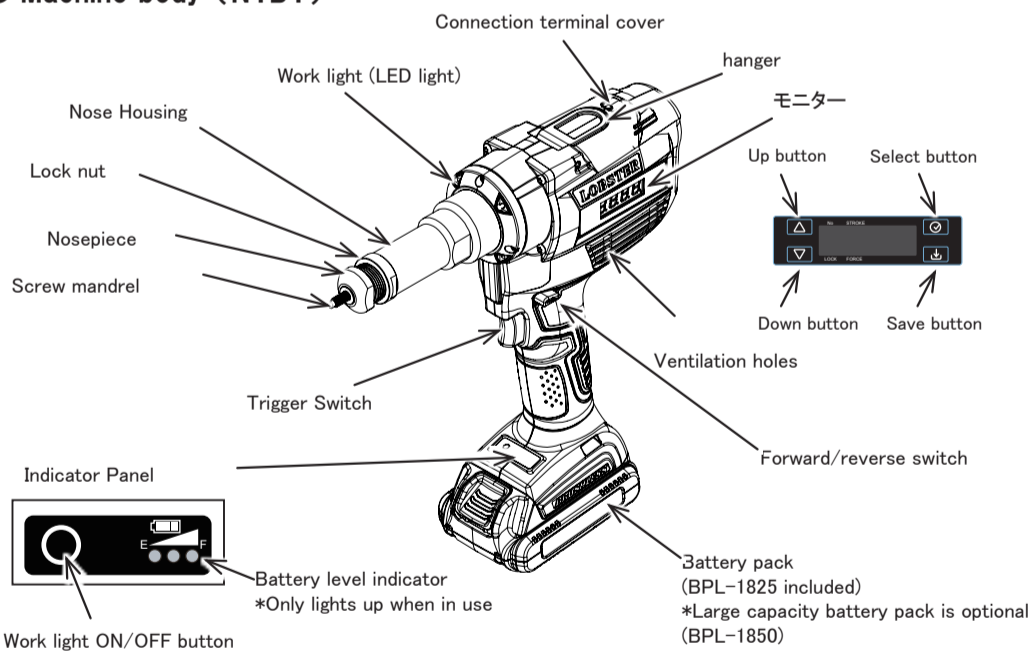

### Replacement parts when changing fastening nuts

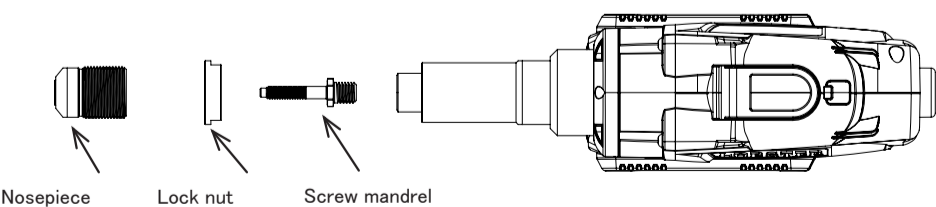

\*Lock nuts are common to all sizes.

### < Installation of Pokayoke tools >

If you purchase the dedicated Pokayoke installation kit (PYSN1H80), you can install the Pokayoke tool (model number TW-800T) from HERUTU ELECTRONICS CORPORATION.

\* Please contact our call center for information on wireless transmitter specifications and Pokayoke installation kits.

### Charger

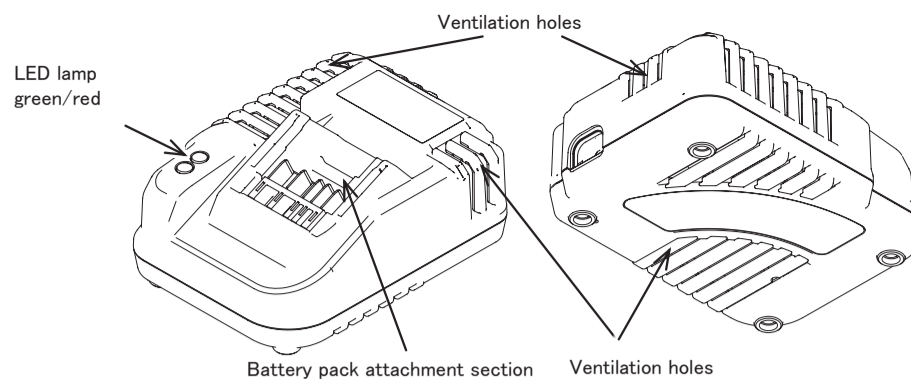

### power cable

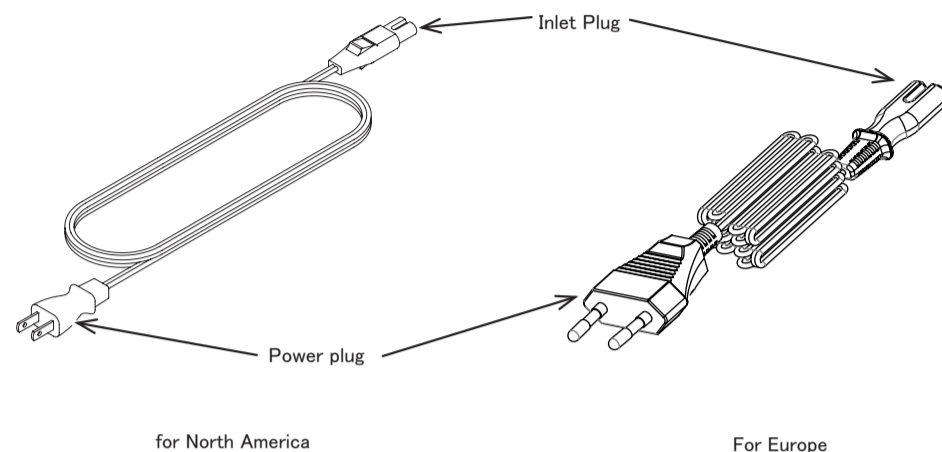

for North America

For Europe

### Battery pack

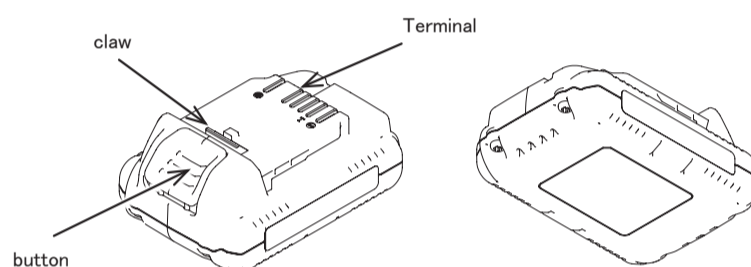

## Set contents

Please make sure that all of the following items, including this unit, are included in the dedicated blow case. We take every precaution when packaging, but if any item is missing, please contact the retailer where you purchased the product or our call center.

1. Cordless Rivet Nut Setter N1B1

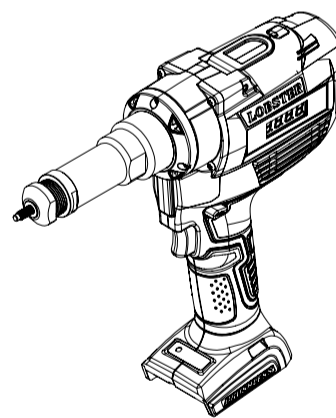

2. Nosepiece

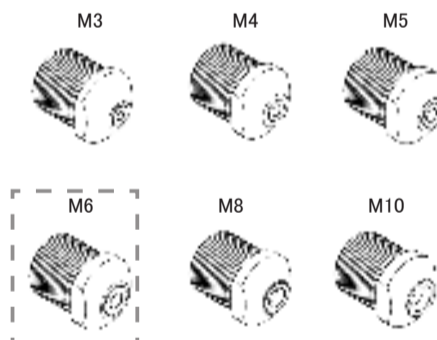

\* The product is shipped with an M6 nosepiece attached.

3. double-ended spanner (2 pieces)

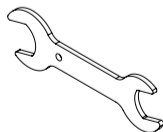

4. Hexagonal L-shaped wrench

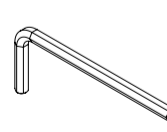

5. Screw mandrel



6. Charger

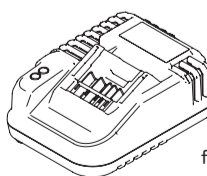

7. power cable

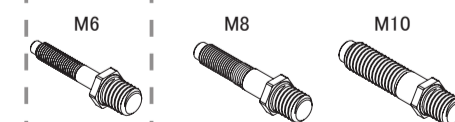
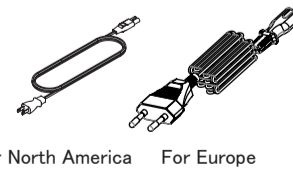

\* The product is shipped with an M6 screw mandrel attached.

8. Battery pack(BPL-1825)

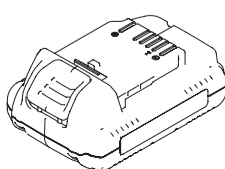

9. Easy Guide (this document)



10. Safety Guide



# ● Initial setting method

Please refer to the table below when entering stroke and output settings.  
For preparations before use and more detailed operating instructions, download the instruction manual from our website and follow the "Preparation before use" section.

## How to input and adjust stroke and output

The stroke and output of this machine must be adjusted according to the thickness of the rivet nut and base material used. Follow the procedure below to input the rivet stroke and output, and adjust so that the rivet nut is properly fitted. Input is done using the buttons next to the monitor display screen.

### ⚠ CAUTION

If no button is pressed for about 3 minutes, the power will turn off. If the input has not been saved, the input will not be reflected and the previous settings will be restored.

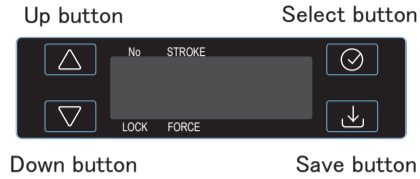

**1** When you pull the trigger switch, the power turns on and the display lights up on the monitor.

**2** Press the Select button (⏏). (For more than 3 seconds but less than 5 seconds) The first two characters will be fully lit, the last two characters will be half lit, and the bar for the second character will be in the center, and the memory number selection screen for saving the settings will appear. Press the Up button (▲) and Down button (▼) to select the memory number to register. (This unit can save 10 settings from memory numbers 0 to 9.)



**3** Press the Select button (⏏) to enter the stroke. (Less than 3 seconds) The first character will be half lit, the next three characters will be fully lit, and the bar for the second character will move to the STROKE position above, and the screen for entering the stroke will appear. Press the Up button (▲) and Down button (▼) to enter the stroke (long press to fast forward). The stroke can be set between 0.1 and 10 mm in 0.1 mm increments.



### ⚠ CAUTION

If you continue to press the Select button (⏏) for more than 3 seconds, your input will be discarded and you will return to the initial screen.

Regarding the stroke value to enter, check the thickness of the base material and check the appropriate caulking from the caulking table attached to the rivet nut you are using.

(Examples)

When the rivet nut caulking table is on the right, and the base material thickness (caulking plate thickness) is 1.0 mm, the appropriate caulking amount is 3.5 mm.

### ⚠ CAUTION

Since there are individual differences between aircraft, adjustments must be made at the end.

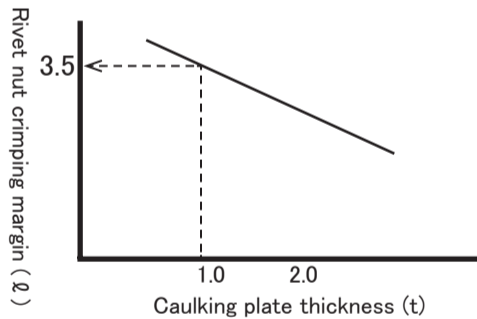

**4** Press the Select button (⏏) to proceed to the crimp output input. (Less than 3 seconds) The first character will be half lit, the next 3 characters will be fully lit, the bar for the second character will move to the FORCE position below, and the screen for inputting the output will appear. Press the Up button (▲) and Down button (▼) to input the output (long press to fast forward). The output can be set in increments of 1 between 01 and 99.



For the output value to be entered, please check the value for the rivet nut to be used from the output setting table for each rivet nut (table on the right).

(Examples)

If you are using our rivet nut "NSK-6M", the output setting table will indicate "60".  
\* If you are using a blind nut from another company that is not listed in the output setting table, please enter "99".

\*The crimping output setting is a function to prevent damage to the screw mandrel or breakage of the rivet nut threads due to excessive crimping (such as double crimping), and is not a function to control the crimping condition by adjusting the output. If you do not need this function, set it to "99".

### ⚠ CAUTION

1. The number is a number that calls up a pre-set output and is not the actual output value.  
2. If you continue to press the Select button (⏏) for more than 3 seconds, the input will be discarded and you will return to the initial screen.

**5** Press the Save button (⏏). (For 2 seconds or more) [Settings complete] the settings will be saved to the memory number selected in [Settings complete]. If you want to check the settings you entered, press the Select button (⏏). The stroke and output settings will be displayed.

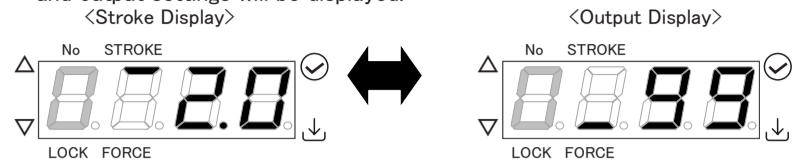

### ⚠ CAUTION

1. If you press the Select button (⏏) instead of the Save button (⏏) (for less than 3 seconds), you will return to the memory number selection screen **2**.  
2. If you press the Select button (⏏) for more than 3 seconds instead of the Save button (⏏), any newly entered settings will be discarded and you will return to the initial screen.

**6** Adjust the rivet nut you are using by actually tightening it.

- Measure the total length of the rivet nut before caulking.
- Measure the total length of the rivet nut after caulking, and calculate the actual caulking margin by subtracting the dimension before caulking from the dimension after caulking.  
\* When tightening the rivet nuts, refer to the "Work Procedure" in the instruction manual.



Caulking dimension (ℓ) =

$$\text{Total length of nut before caulking} - \text{Total length of nut after caulking}$$

- Adjust the stroke input value so that the caulking margin is within  $\pm 0.3\text{mm}$  of the appropriate caulking margin. (Even if you adjust the stroke input value, if the appropriate crimping distance cannot be achieved, the output may not be enough. Adjust by increasing the output one step at a time.)



### ⚠ CAUTION

- Since there are individual differences between aircraft, adjustment is required for each aircraft even if the same rivet nut is used.
  - When increasing the adjustment value, increase it gradually. If it is raised too high, it may damage the threads of the rivet nut or damage the machine body, such as the screw chuck.
  - If the stroke is too small or the force is too weak, the rivet nut may not be tightened enough and may cause the rivet nut to spin idly.
  - If the stroke is too large and the output is too strong, the rivet nut may be too tight and the thread may break.
- \* Large stroke and force will damage the nut.

Output value setting table for our rivet nuts

Thread Size		M3	M4			M5				
Our product number		3M	4M	415M	425M	435M	5M	515M	525M	535M
Product number (NTK)		3M15	4M	4M20	4M25	4M35	5M	-	5M30	-
NSK	Force No.	05	30	20	15	20	40	45	45	35
NSD	Force No.	-	40	15	15	15	70	40	45	50
NAK	Force No.	-	10	10	10	05	20	15	15	15
NAD	Force No.	-	10	10	05	05	20	20	15	15
NTK	Force No.	30	40	40	35	40	55	-	55	-
NSK-MR	Force No.	-	30	-	-	-	45	-	-	-
NSD-MR	Force No.	-	15	-	-	-	50	-	-	-

Thread Size		M6			M8			M10		
Our product number		6M	625M	640M	8M	825M	840M	10M	1025M	1040M
Product number (NTK)		6M	-	6M40	8M	-	8M40	10M	-	10M40
NSK	Force No.	60	55	65	65	80	85	80	85	95
NSD	Force No.	65	60	60	85	85	85	-	85	85
NAK	Force No.	40	45	45	70	50	55	-	55	55
NAD	Force No.	45	45	50	55	50	65	-	55	50
NTK	Force No.	55	-	70	65	-	99	65	-	95
NSK-MR	Force No.	60	-	-	95	-	-	99	-	-
NSD-MR	Force No.	70	-	-	95	-	-	-	-	-

\* When using the NSK-6M rivet nut, the setting is "60".

\* "-" in the table indicates that it is not included in our standard rivet nut lineup.

## ● Serial No.

\* The serial number of the cordless rivet nut setter is displayed on the bottom of the unit as three letters (date of manufacture) and a five-digit number.

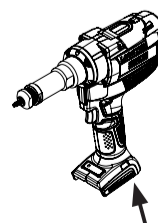

Bottom of main body

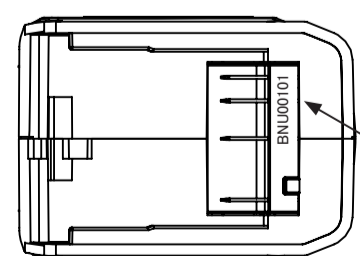

Serial number location

How to view the manufacturing year/month

Manufacturing year/month	1	2	3	4	5	6	7	8	9	10	11	12
Code	A	B	M	N	K	W	T	Y	U	O	L	Z

Examples) 2 0 ② ④ Year ⑫ Month

Serial number  
 ↓ ↓ ↓  
 B N Z ⇒ BNZ 00000