

43526970
WEIGHT BENCH
Instruction manual

WARNING MEASURES











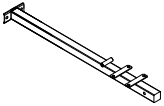
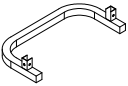

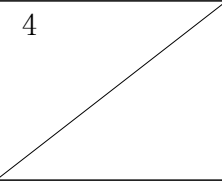
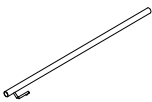
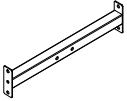

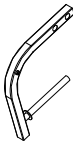

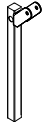



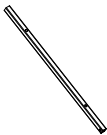

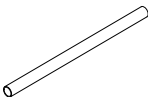



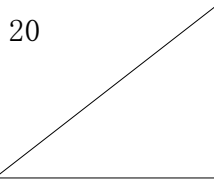
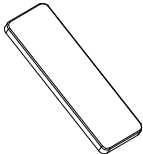
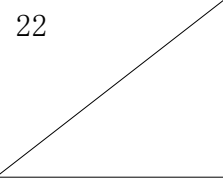
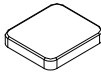







This training device was designed to ensure optimum safety. However, it is recommended to take certain precautions each time you use a training device. Read all the instructions before installing or operating the device. In particular, note the following precautions:

- a. Keep children and animals away from the device at all times. DO NOT leave unattended children in the room with the device.*
- b. Only one person may use the device at the same time.*
- c. If you experience dizziness, nausea, chest pain or other abnormal symptoms, you should stop training and CONTINUE with your doctor.*
- d. Set the device on a clean, level surface. DO NOT use equipment near water or outside.*
- e. Keep your hands off the moving parts.*
- f. Suitable training clothes should always be worn during the exercise. You must not wear a robe or other clothing that may be caught by the device. Shoes are also required for running or aerobics.*
- g. Use the device only according to its purpose as described in this manual. NO use accessories other than those recommended by the manufacturer.*
- h. DO NOT place any sharp objects near the device.*
- i. Persons with disabilities should not use the device without a qualified presence a health care professional or a doctor.*
- j. You should always stretch before exercising.*
- k. Never use the device if it does not work properly.*
- l. A flat key or a hexagon key may be used to complete the assembly.*

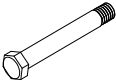
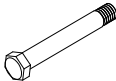
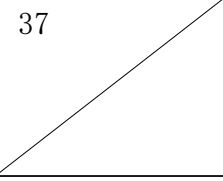
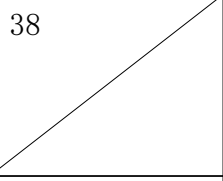
NOTE: BEFORE YOU INITIATE YOUR TRAINING PROGRAMME OR OTHER TRAINING PLAN, CONTACT YOUR DOCTOR. This is particularly important in the case of persons over 35 years of life or persons with health problems arising further. BEFORE YOU USE ALL INSTRUCTIONS. WE CANNOT BE RESPONSIBLE FOR ANY INJURY

PERSONS OR MATERIAL INJURY RESPONSIBLE FOR USE WITH THIS PRODUCT.

List of accessories

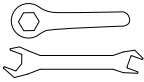
1 	2 	3 	4 	5 
6 	7 	8 	9 	10 
11 	12 	13 	14 	15 
16 	17 	18 	19 	20 
21 	22 	23 	24 	25 
26 	27 	28 	29 	30 
31 	32 	33 	34 	35 
36 	37 	38 	39 	40 
41 	42 	43 	44 	45 

NO.	DESCRIPTION	Qty.
1	body frame	1
2	Foot tube	1
3	Rear Upright Tube	2
4	-----	--
5	bumper	1
6	crossbeam	1
7	Left rocker arm	1
8	Right rocker arm	1
9	Support Plate	1
10	Biceps pad adjustable tube	1
11	Front Upright Tube	1
12	Leg Curl Tube	1
13	Clip	3
14	Back Cushion Tube	2
15	Short Foam Tube	2
16	Foam Tube	3
17	Left safety hook	1
18	Right safety hook	1
19	Knob M10	1
20	-----	--
21	Back Cushion	1
22	-----	--
23	Seat Cushion	1

NO.	DESCRIPTION	Qty.
24	Foam	8
25	Round End Cap	2
26	Cap	1
27	Square Inner Cap 38X38MM	10
28	Cap ø25MM	5
29	Round End Cap	1
30	Cap ø19MM	10
31	Nut M6	2
32	Screw M10X55	6
33	Washer 10	20
34	Nut M10	10
35	Screw M10X120	1
36	Screw M10X110	2
37	-----	--
38	-----	--
39	Screw M10X65	1
40	Screw M8X40	4
41	Washer 8	21
42	Screw M8X16	11
43	Screw M8X20	6
44	Cap 25X25MM	4
45	TOOLS	3

Schedule of distributed elements

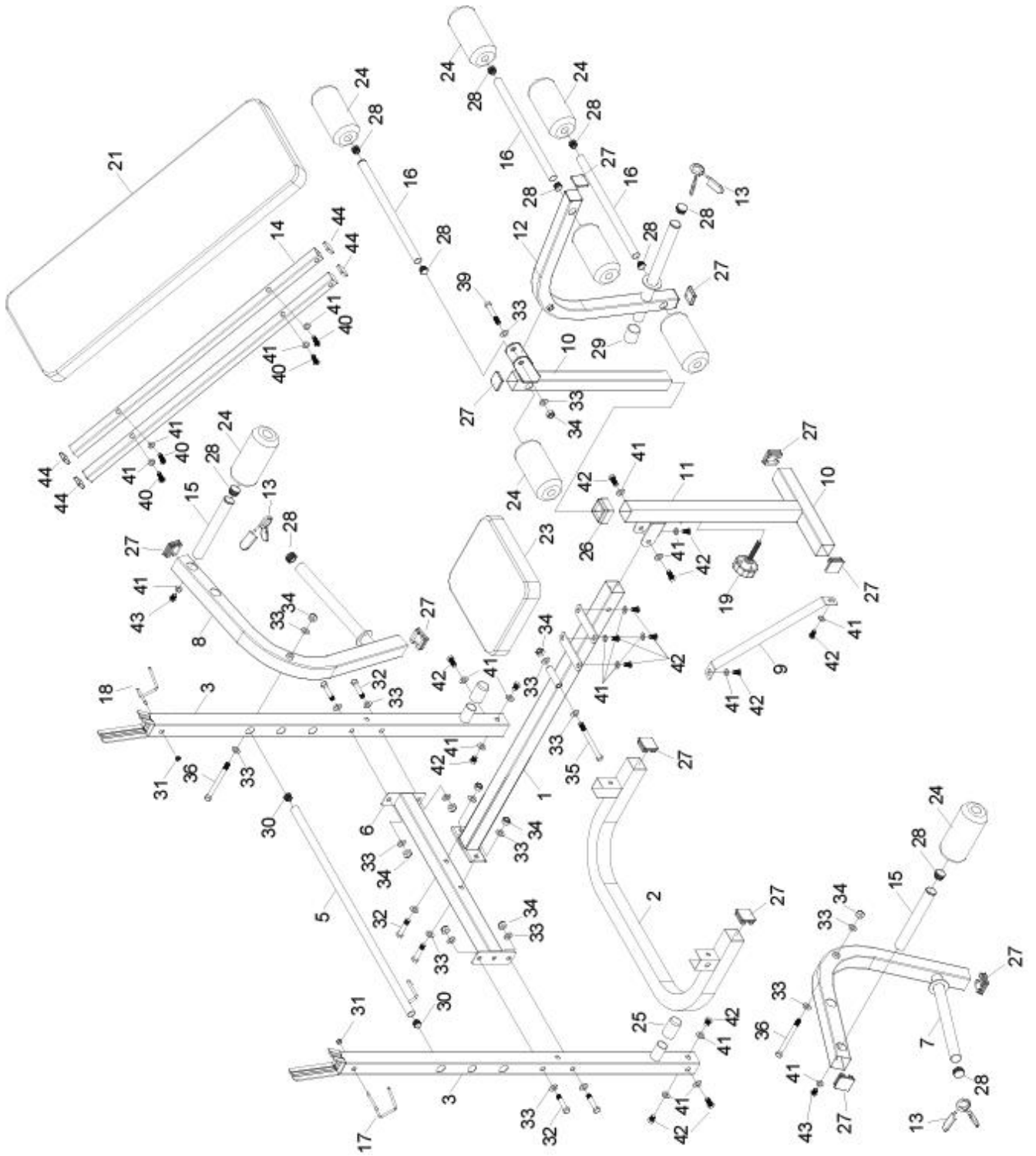

Note: Do not tighten the screws during installation. Tighten all screws after the entire product is installed

Step:1

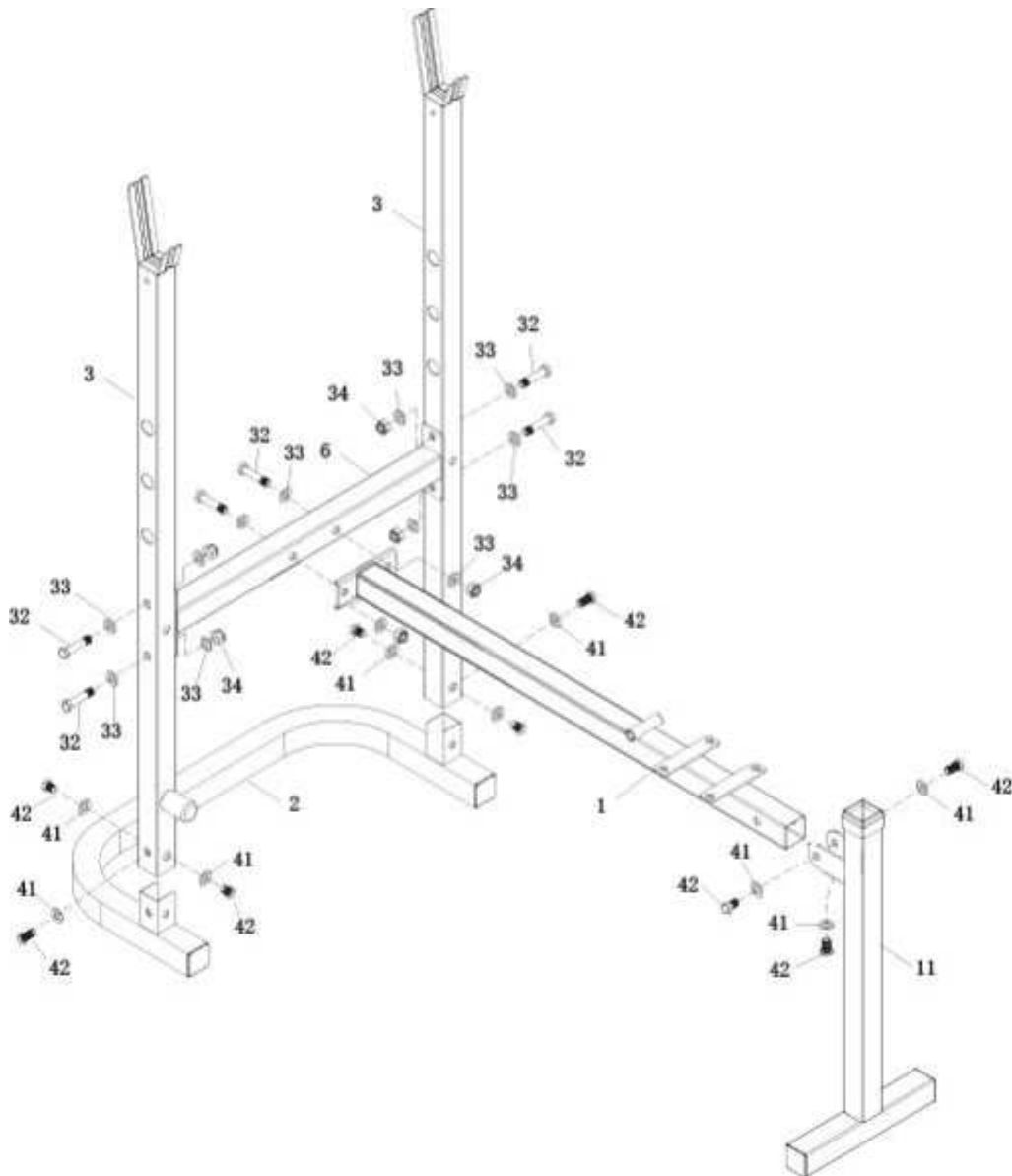

Step:1

- 1. Fix (3) 2pcs and (6) with (32) and (33) (34) as shown.**
- 2. Fix the installed (3) and (2) connections (42) and (41) as shown in the figure**
- 3. Attach(1)to(6)with(32)and(33)(34)as shown.**
- 4. Attach(1)to(11)with(42)and(41)as shown**

Step:2

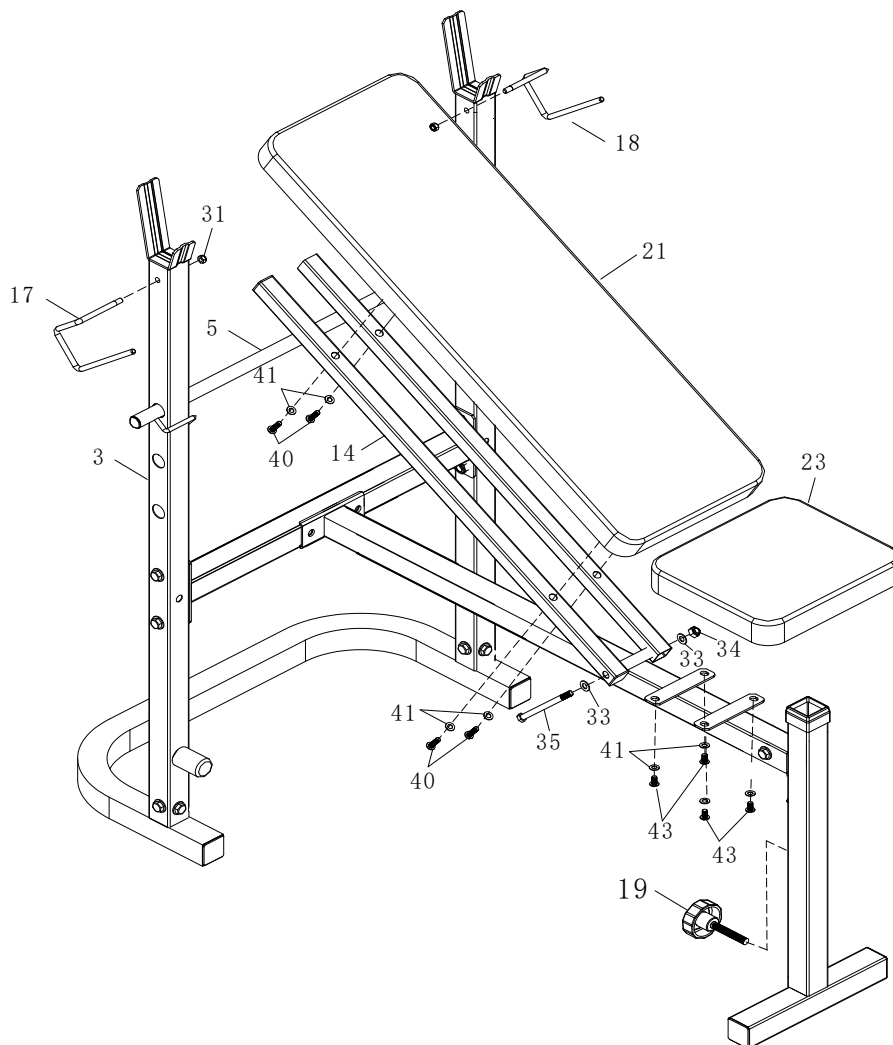

1 Place insert (35) in part (14)(1) with (33)(34) as shown.

2 Attach part (21) to part (14) using (40)(41) as shown.

3 Attach part (23) to part (1) using (40)(41) as shown.

Step:3

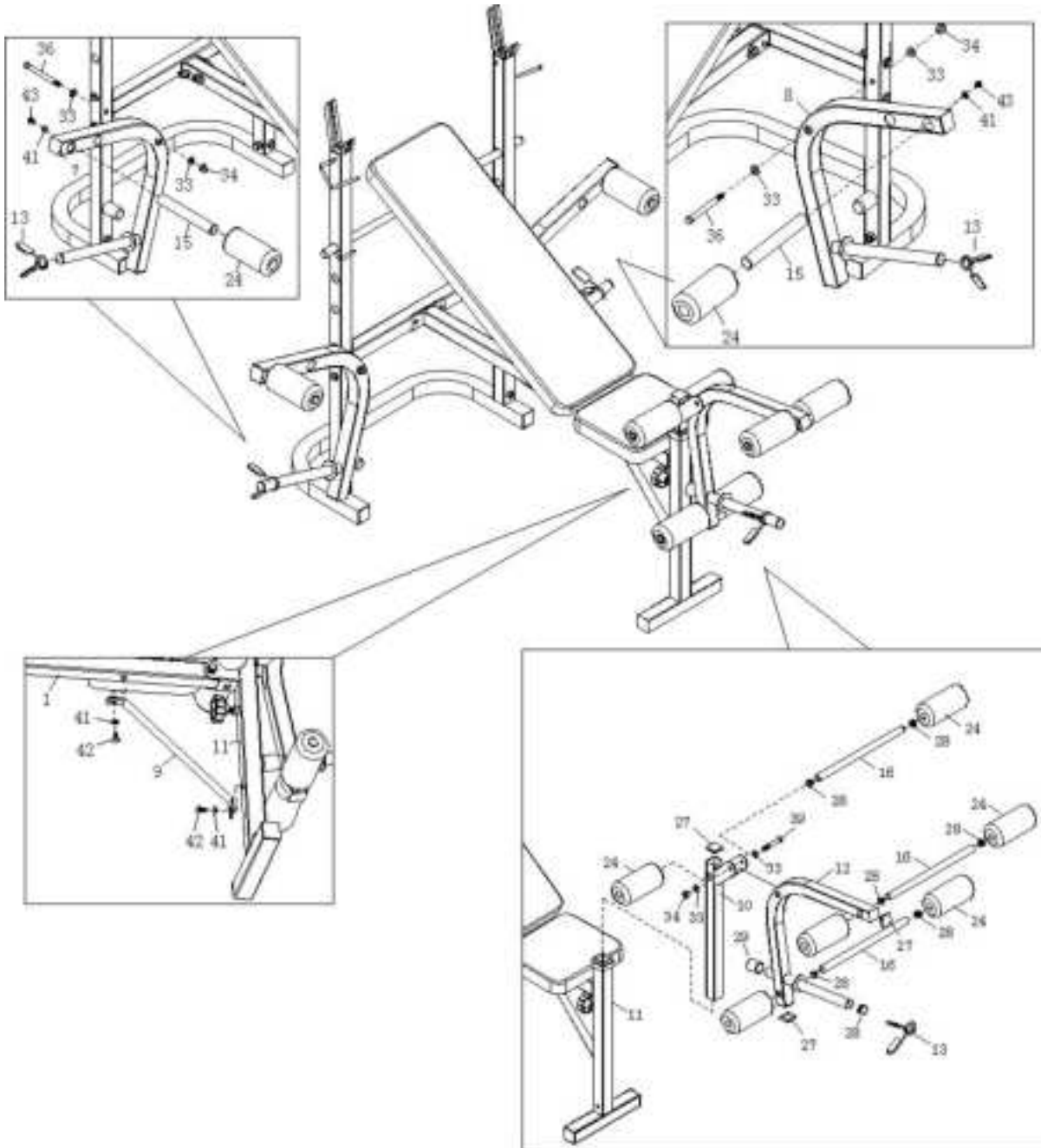

1. Fix (7) and (3) with (36) and (33) (34) . Place insert (15) in part (7)with(43)(41) as shown,put (24) cover on (15).
2. Fix (8) and (3) with (36) and (33) (34) . Place insert (15) in part (7)with(43)(41) as shown,put (24) cover on (15).
3. Place insert (10) in part (11)with(19) ,Fix (12) and (10) with (39) and (33) (34) as shown,Place insert (16)in part(10)(12) ,and put (24) cover on (16).
4. Fix (9) and (11)(1) with (42) and (41) as shown.