

**Item Number: A0531601**

**WARNING (To reduce the risk of fire, electric shock, or personal injury):**

1. We suggest installation by a **licensed electrician**.
2. Please read the instruction carefully and save it as you may need it at a later time.
3. Before you start, **NEVER** attempt any work without shutting off the electricity until the work is done.
  - » Go to the main fuse, or circuit breaker, box in your home.  
Place the main power switch in the “**OFF**” position.
  - » Place the wall switch in the “**OFF**” position.
1. Mounting surface should be clean, dry, flat, strong enough and 1/4” larger than the canopy on all sides. Any gaps between the mounting surface and canopy exceeding 3/16” should be corrected as required.
2. Make sure that the ceiling or wall can stand the weight of the lamp before installation.
3. Make sure the voltage you are using is **120V**. The maximum wattage is **LED, 9W**.
4. Keep the lamp away from acidic and alkaline substances in case of damaging the surface of the lamp.
5. When replacing bulbs, you should turn off or unplug the lamp and you must wait until it is cool as bulbs get hot quickly.
6. The safety instructions appearing in this manual are not meant to cover all possible conditions that may occur. It must be understood that common sense, caution and care must be used with any electrical products.

**IMAGE FOR FINISHED PRODUCT:**

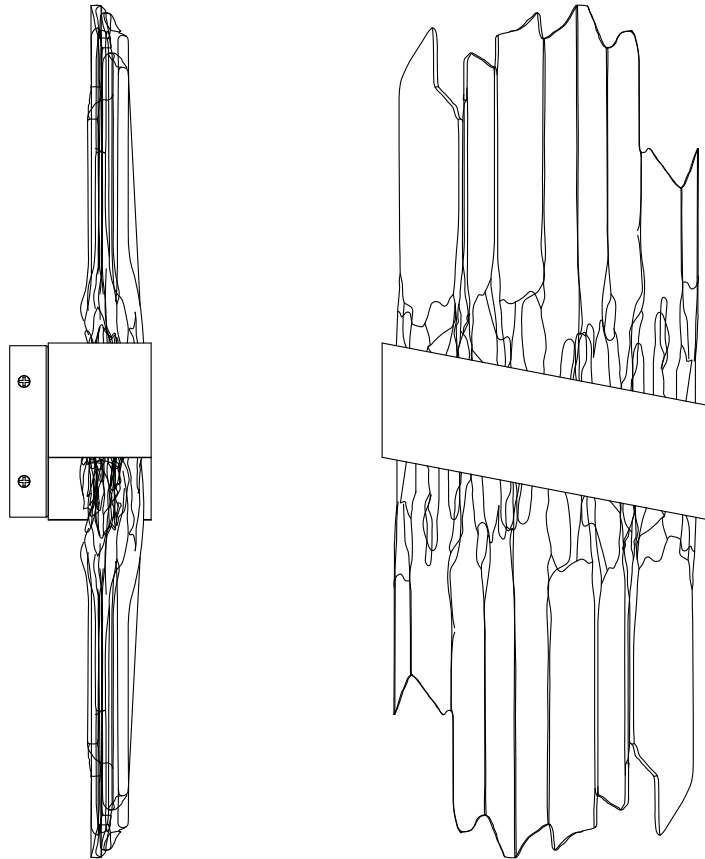

**TOOLS REQUIRED (NOT INCLUDED):**

Before starting assembly and installation please prepare the needed tools as below picture

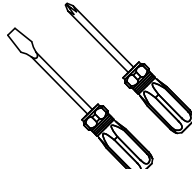
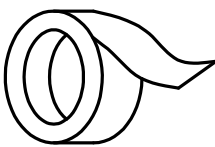
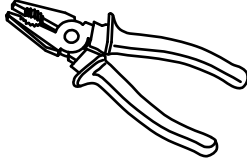
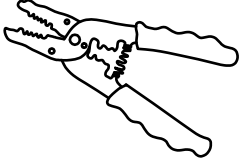
				
Ladder	Philips Head or Flat Blade Screwdriver	Electrical Tape	Pliers	Wire Cutter/Stripper

**PARTS TYPE & QTY INCLUDED:**

- (E) Mounting plate (1)
- (F) Screw (4)
- (G) Back plate (1)
- (H) Body (1)

**ACCESSORIES & QTY ENCLOSED:**

- (A) Anchor (2)
- (B) Mounting screw (2)
- (C) Anchor screw (2)
- (D) Plastic wire connector (3)

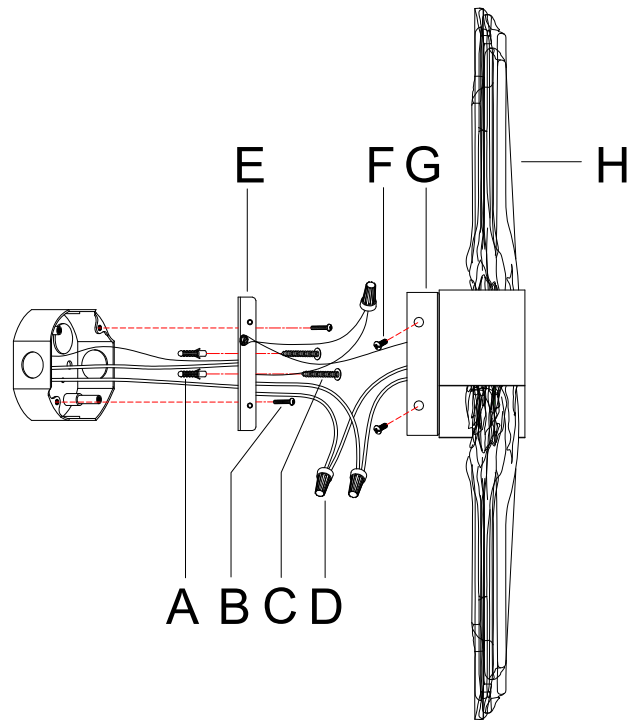

**ASSEMBLY & INSTALLATION INSTRUCTIONS:**

1. Carefully remove the fixture from the carton and check that all parts and accessories are included as shown in the above illustration.
2. Turn off power  
 Before you start the installation, NEVER attempt any work without shutting off the electricity until the work is done.
  - » Go to the main fuse, or circuit breaker, box in your home. Place the main power switch in the "OFF" position.
  - » Place the wall switch in the "OFF" position.

**3. Make installation**

<p><b>A1</b></p>	<p><b>A2</b></p>	<p><b>A5</b></p>						
<p><b>A3</b></p> <table border="1" style="width: 100%; margin-top: 10px;"> <tr> <td style="width: 20px;"></td> <td style="width: 20px; text-align: center;">1/2 inch</td> <td style="width: 20px;"></td> </tr> <tr> <td style="text-align: center;">[Wire with 1/2 inch exposed]</td> <td style="text-align: center;">exposed wire</td> <td></td> </tr> </table>		1/2 inch		[Wire with 1/2 inch exposed]	exposed wire		<p><b>A4</b></p>	
	1/2 inch							
[Wire with 1/2 inch exposed]	exposed wire							

**Step A1 »** Unscrew screws (F) from back plate (G) then gently remove mounting plate (E). Then set them aside for later installation.

**Step A2 »** Carefully pass the supply wires from the outlet box through mounting plate (E).

- 1) NOTE: To drill the holes in the wall for anchors (A), attach mounting plate (E) to wall with screws (B & C)
- 2) Attach mounting plate (E) to outlet box and then mark the position of holes in the wall with a pen as shown in the illustration.
- 3) Drill holes and gently knock anchors (A) into the marked holes until anchors (A) are level with the wall.
- 4) Secure mounting plate (E) to the wall with screwing anchor screws (C) into anchors (A) and mounting screws (B) into holes of mounting plate (E).

**Step A3 »** Make wire connections

Connect wires as shown in the charts below. **PLEASE NOTE THAT GROUND WIRE IS BARE COPPER WIRE, NEVER CONNECT OTHER WIRES TO GROUND WIRES.**

Connect ground wires according to the chart below

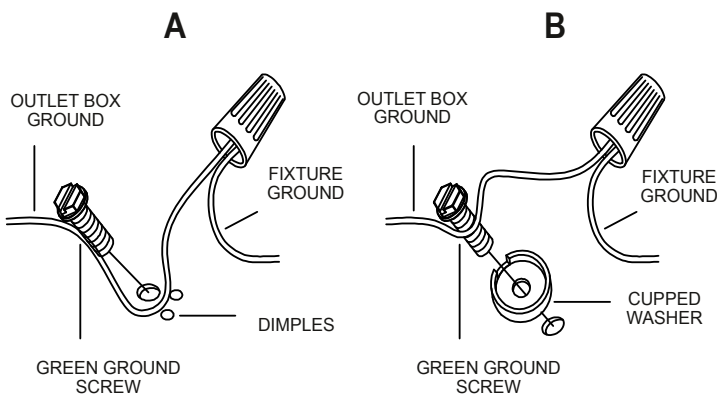

Connect wires according to the chart below

Connect Black or Red Supply Wire to:	Connect White Supply Wire to:
Black	White
*Parallel cord (round & smooth)	*Parallel cord (square & ridged)
Clear, Brown, Gold or Black without tracer	Clear, Brown, Gold or Black with tracer
Insulated wire (other than green) with copper conductor	Insulated wire (other than green) with silver conductor

\* Note: When parallel wires (SPT I & SPT II) are used. The neutral wire is square shaped or ridged and the other wire will be round in shape or smooth (see illus.)

**Twist wires together with plastic wire connectors until tightly joined, and wrap each connector with approved electrical tape. Be sure that no wire strands are exposed and then carefully tuck all wires into the outlet box.**

**Step A4 »** 1) Position back plate (G) in place.

- 2) Carefully thread screws (F) through the holes in back plate (G) and mounting plate (E) and then secure them by tightening screws (F).

**Step A5 »** Check that everything is installed properly, then you can turn on the light. We hope you enjoy your new lighting!

## ORDERING PARTS

Keep this sheet for future reference in case you need to order replacement parts. All parts for this fixture can be ordered from the place of purchase. Be sure to use exact wording from illustration when ordering parts.

## CLEANING

To clean, wipe the fixture with a soft cloth. Do not use abrasive materials such as scouring pads or powders, steel wool or abrasive paper.