

**ELEGOO**

● **Saturn 4 Ultra  
3D Printer**

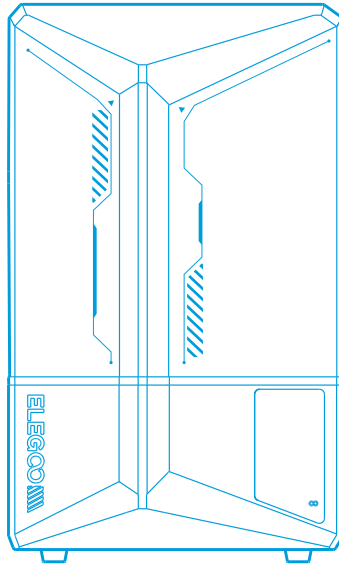

# User Manual

**Thank you for purchasing ELEGOO brand products.**

---

**V7** ●

After receiving the product, please confirm whether the equipment is intact and the accessories are complete. If there is any damage or missing, please timely contact us at [3dp@elegoo.com](mailto:3dp@elegoo.com). (To ensure the performance of each product, each product will undergo strict printing tests before leaving the factory. There may be some slight scratches when you receive the product, which is normal, please rest assured to use.)

## Notice:

---

- Please keep the 3D printer and its accessories out of the reach of children.
- Please fill the resin tank no less than 1/3 of its volume, but do not exceed the MAX line position.
- Please place the printer in a dry environment and protect it from rain and moisture.
- If you run into an emergency during use, please turn off the power supply of the 3D printer first.
- Please use the printer indoors and avoid direct sunlight and a dusty environment.
- Please keep the original packaging box for 30 days for return/exchange (only ELEGOO original packaging boxes are accepted).
- If the printing fails, you need to clean the excess cured resin in the resin tank and change the resin, otherwise, it may cause damage to your printer.
- When operating the 3D printer, please wear a mask and gloves to avoid direct skin contact with the photopolymer resin.
- If the release film in the resin tank is whitened, scratched, or has no elasticity, the printing failure rate is high, please replace the release film in time.
- Please use 95% (or higher) ethyl alcohol or isopropyl alcohol to wash your model unless you are using water washable resin.
- Please note that the Mylar tape surrounding the screen is not completely airtight. In case of resin drips during use, it is crucial to promptly clean them to prevent resin infiltration and potential screen damage.
- To maintain the cleanliness, durability, and protective performance of the LCD screen, it is necessary to timely replace parts under the following conditions: aged or damaged tape, corrosive damage, and damaged release film.
- If you have any problems with the printer, please contact us at [3dp@elegoo.com](mailto:3dp@elegoo.com). Please do not disassemble or modify ELEGOO 3D printers by yourself, otherwise, the warranty will expire, and damage caused by personal operating errors need to pay for repairs.

## Contents

---

Packing List .....	01
Printer Introduction .....	02
3D Printer Tech Specs .....	04
Device Self-Check .....	05
Test Printing .....	06
Software Installation and Setup .....	07
Network Management Center .....	09
AI Camera .....	10
Resin Calibration .....	11
Firmware Upgrade .....	13
FAQ .....	14
Machine Maintenance .....	16
Warranty Statement .....	17

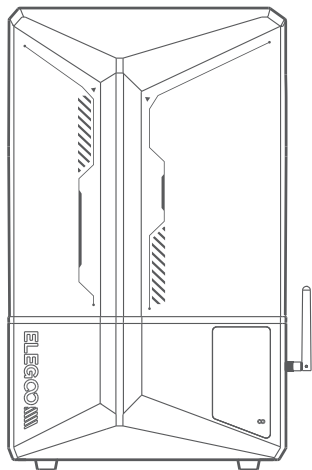

Saturn 4 Ultra 3D Printer



Wifi Antenna

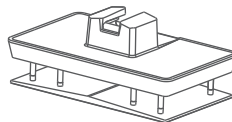

Build Plate

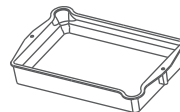

Resin Tank

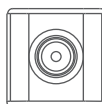

AI Camera



Drip Tray



USB Flash Disk



Mask

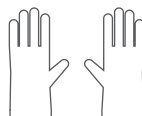

Gloves



Funnel



Backup Screws



User Manual



Adapter



Tool Kit

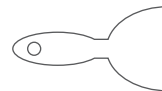

Scraper

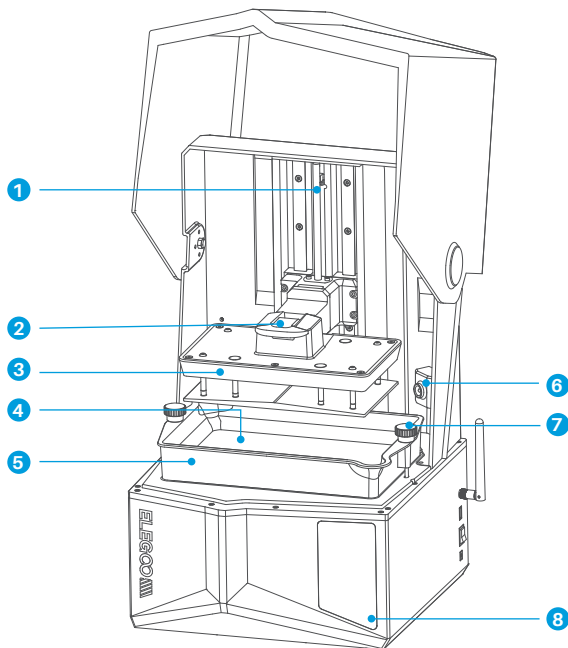

**1**  
Z Axis

**2**  
Handle

**3**  
Build Plate

**4**  
LCD Display Screen

**5**  
Resin Tank

**6**  
AI Camera

**7**  
Screw Knob

**8**  
Touch Screen

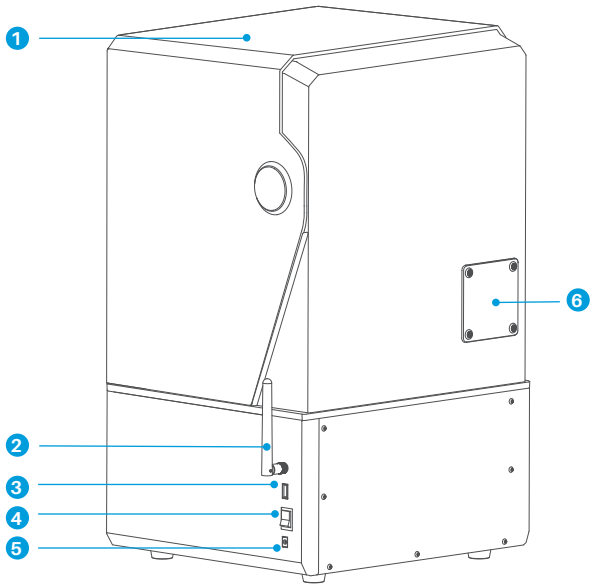

1  
Anti-UV Cover

2  
Wifi Antenna

3  
USB Interface

4  
Switch

5  
DC Socket

6  
Extension Port (Connect peripherals, such as a mini heater and other compatible printer accessories)

### Printing Parameter

- System: EL3D-4.0
- Operation: 4.0-inch Capacitive Touch Screen
- Slicer Software: CHITUBOX
- Connectivity: USB Interface & WiFi
- AI Camera: Built-in 1920\*1080 Resolution

### Hardware Specification

- Dimension: 327.4mm(L)\*329.2mm(W)\*548mm(H)
- Build Volume: 218.88mm(L)\*122.88mm(W)\*220mm(H)
- Package Size: 650mm(L)\*420mm(W)\*430mm(H)
- Gross Weight: 17.7KG
- Net Weight: 14.5KG

### Printing Specification

- Technology: MSLA Stereolithography
- Light Source: COB Light Source + Fresnel Collimating Lens (wavelength 405nm)
- XY Resolution: 19\*24um (11520\*5120)
- Z-axis Accuracy: 0.02mm
- Layer Thickness: 0.01-0.2mm
- Printing Speed: MAX 150mm/h
- Power Requirements: 100-240V 50/60 Hz 24V6A



**Note:** Upon startup, the printer conducts a self-check on key hardware components to prevent any printing failures due to hardware malfunctions. Please refer to the error prompts on the machine to troubleshoot the printer. Do not touch the printer during the self-check process. (See [Picture 1](#))

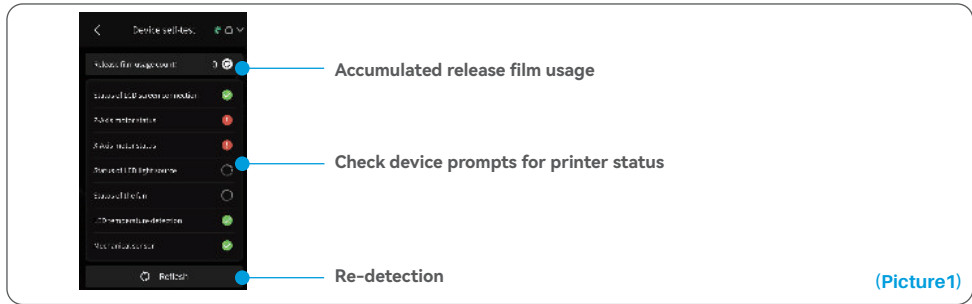

When the accumulated usage of the release film is approaching 60,000 times, the device will issue a reminder to replace the release film promptly. Click the refresh button on the device self-check page to reset the counter manually. (See [Picture 2](#))

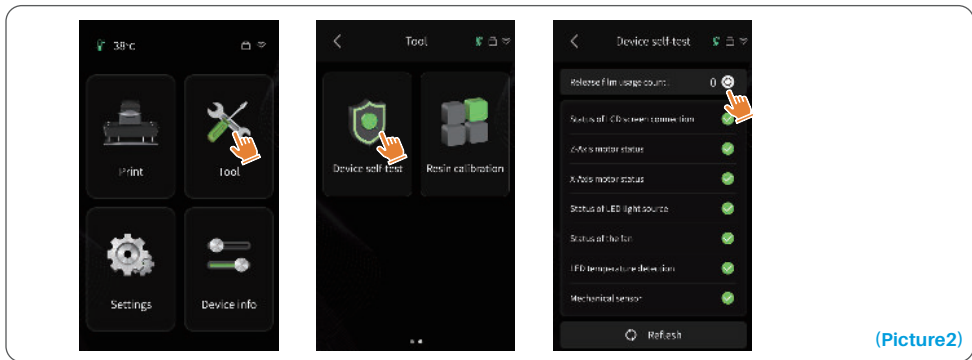

### 1. Print Preparation

Before using, make sure to utilize the provided tool to remove the fixed screws on the resin tank. Replace them with the screw knob included in the tool kit.

After inserting the build plate into the connecting block, press down the handle to secure the build plate to the connecting block (the build plate is capable of self-leveling and ready to use right out of the box).

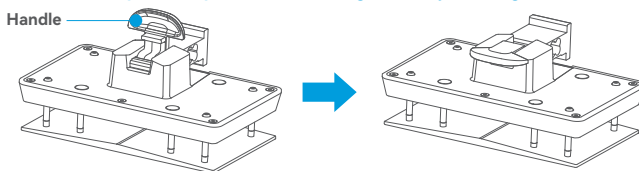

### 2. Model Printing

Slowly add the resin into the resin tank (the resin level is not less than 1/3 of the tank volume and does not exceed the MAX line. The machine will perform a self-check before printing, and do not touch the machine during the self-check). Cover the printer's anti-UV cover and then select the sliced test model for printing.

### 3. Model Processing

After printing is completed, insert the drip tray parallel to the resin tank, fasten the screw knobs on both sides, and install the drip tray onto the printer. The tray prevents resin drips onto the machine when removing the build plate. Then, lift the handle to take out the build plate, and use a scraper to remove the model. You can use ELEGOO's cleaning and curing machine to post-process the model.

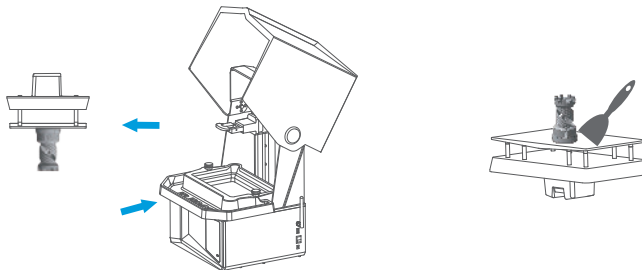

The printer supports the installation package of CHITUBOX from the USB flash drive.

### 1. Install CHITUBOX

Select from the USB flash drive or go to CHITUBOX official website ([www.chitubox.com](http://www.chitubox.com)) to download the right slicing software version and install it on your computer.

### 2. How to Use CHITUBOX (See Picture 3)

After the installation is complete, run the CHITUBOX software. Select ELEGOO Saturn 4 Ultra as your default printer and click "Next" to enter the "Printer Settings" page.

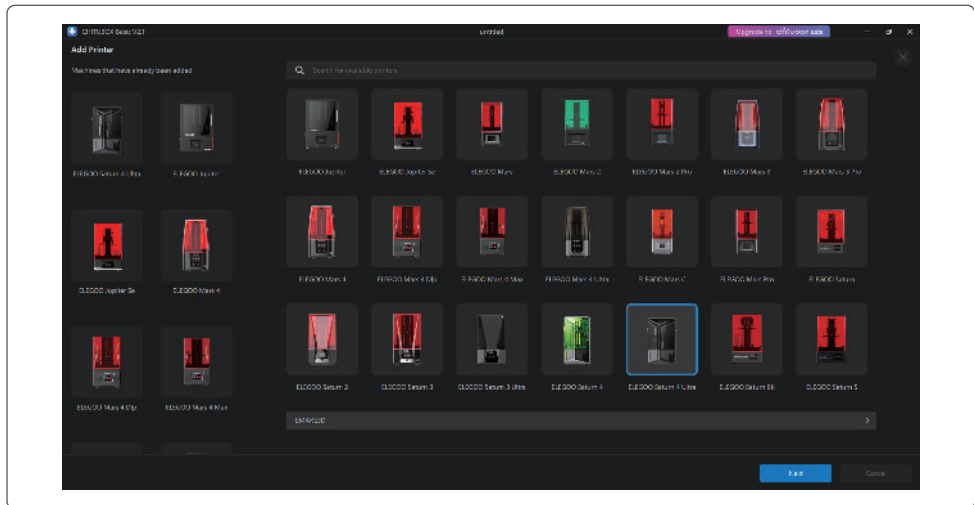

(Picture3)

### 3. CHITUBOX Setting

#### 3.1 Machine Configuration Parameters

Navigate to the "Slicing Settings" page. You don't need to change the default machine parameters (See [Picture 4](#)), and X indicates the maximum print size in the X-axis direction, and so on.

### 3.2 Resin Parameter (See Picture 4)

**Resin Density:** 1.1g/ml

**Resin Cost:** You can input the real price of the resin you purchased, and the slicing software can calculate the resin costs for each model you print.

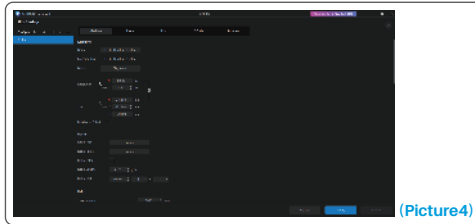

(Picture4)

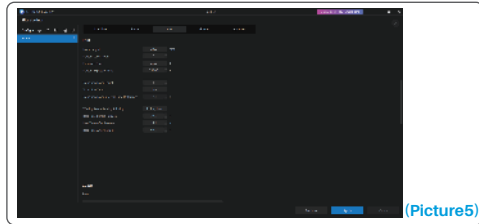

(Picture5)

### 3.3 Parameters (See Picture 5)

**Layer Height:** The thickness of each printed layer, the recommended height is 0.05mm, but you can set it from 0.01-0.2mm. The higher the thickness you set, the longer the exposure time will be required for each layer.

**Bottom Layer Count:** The setting number of initial printing layers. If the number of bottom layers is n, the exposure time of the first n layers is the exposure time of the bottom layer. The default setting is 5 layers.

**Exposure Time:** The exposure time for normal printing layers. The default exposure time is 2.5 seconds, and the thicker the printing layer setting is, the longer the time it will take.

**Bottom Exposure Time:** The setting of bottom layer exposure time. Properly increasing the bottom exposure time can help to increase the stickiness between the printed model and the printing platform, and the default setting is 35 seconds.

**Transition Layer Count:** The number of transition layers after the bottom layers for a tighter bonding between layers. Except for the exposure time, other parameters of the transition layers are the same as those of the normal layers.

**Transition Type:** Set the transition type of exposure time when transitioning from bottom layers to normal layers, the default setting is linear transition.

**Rest Time Before Release:** The interval between print exposure completion and printer release initiation. The default setting is 0 seconds.

**Rest Time After Release:** The interval between printer release completion and printer return initiation. The default setting is 0 seconds.

**Rest Time After Retract:** The interval between printer return completion and the start of exposure. The default setting is 1 seconds.

**Note:** 1. This machine uses the tilt-release method for printing, and does not require additional settings for Z-axis movement parameters. You can switch between fast and slow printing modes within the machine's internal settings.

2. The printing parameters listed in this manual are for reference only. In actual applications, please contact the official after-sales technical support to confirm the parameters based on comprehensive factors such as the machine model and resin (including type and color) used by the individual.

1. Open the slicing software and click  in the upper right corner to enter "Network Management Center" (You need to download and install ChituManager for first time use.) (See [Picture 6](#))

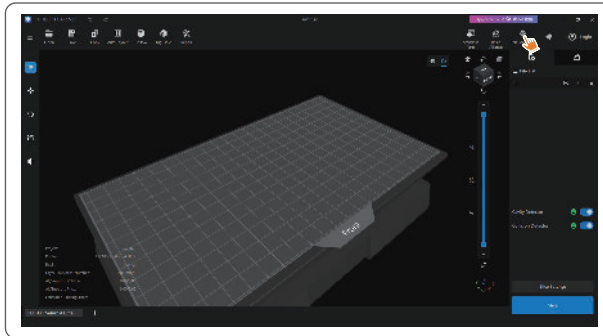

(Picture6)

2. After entering the Network Management Center, click "Add Printer" to associate the printer (make sure the computer and printer are in the same LAN). After associating the device, you can remotely control it through the software. (See [Picture 7](#))

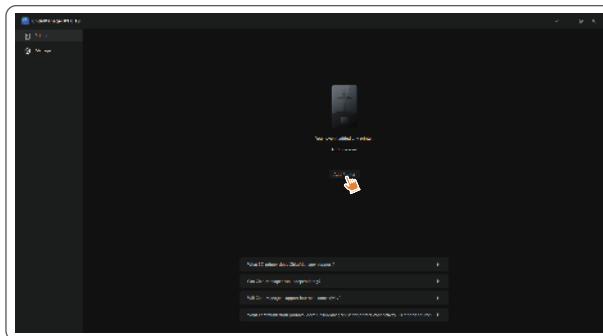

(Picture7)

1. In the printer management interface, you can turn on the AI camera to observe the printing situation in real time. You can also choose whether to activate the time-lapse photography feature before starting a print. The generated time-lapse videos can be saved in the history records. (See [Picture 8](#))

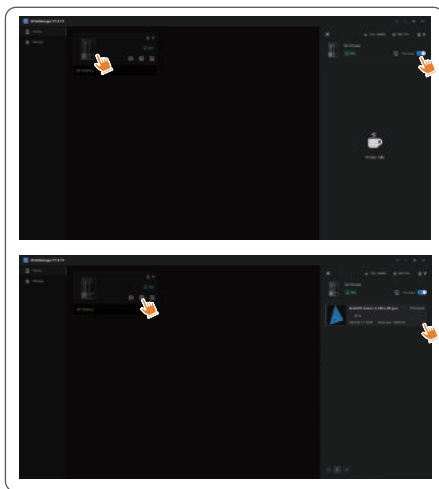

(Picture8)

**Notes:**

1. The AI camera's shooting quality may decrease under poor lighting conditions.
2. Time-lapse photography can only be used when the model height exceeds 50mm. Time-lapse recording starts at 30mm height and requires additional processing time after the print is completed in order to generate the time-lapse videos. The processing time is directly proportional to the model height.
3. The device can store up to 20 time-lapse photography videos. Once the storage is full, the videos will be automatically replaced in the order they were generated. Therefore, please download your time-lapse videos promptly.
4. Only when the model height exceeds 100mm, the AI camera will detect abnormal conditions such as anomalies on the build plate or warping edges.
5. With continuous deep learning, the AI camera's detection and judgment of anomalies will become more accurate. Please pay attention to the camera's upgrade information to assist you in completing the printing tasks more effectively.

Choose the appropriate section mode for the model (the screen exposure area will be divided into 4, 6, or 8 equal sections depending on the selected mode). Click the "+" button to import the sliced model (please ensure that the model is not placed on the section boundaries, refer to Picture 10 for the section positions). Set the exposure time for each section, starting from Zone 1 (the exposure times for each section should be set in a decreasing or equal manner). Click "Start" to begin printing. You can determine the optimal resin exposure parameters based on the printing results. The following example demonstrates the use of a 4-section mode. (See Picture 9)

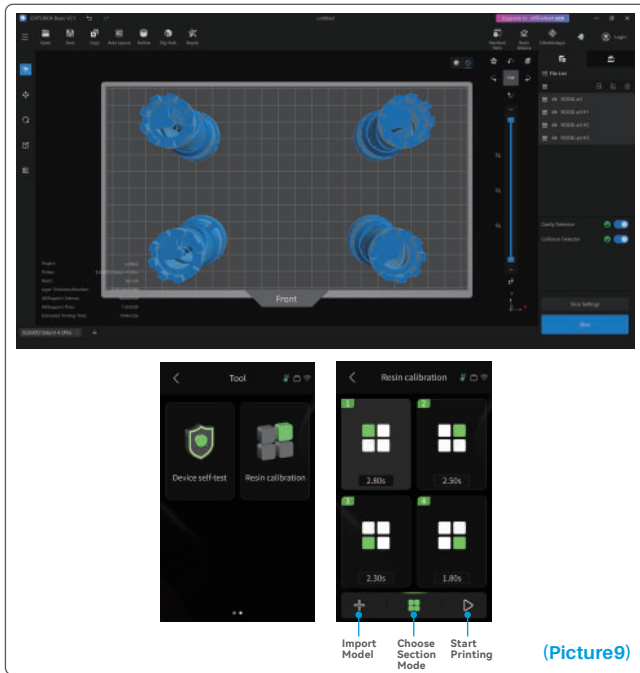

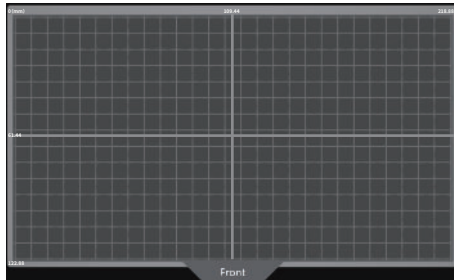

(4-Section Mode)

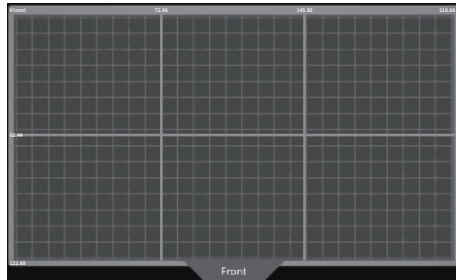

(6-Section Mode)

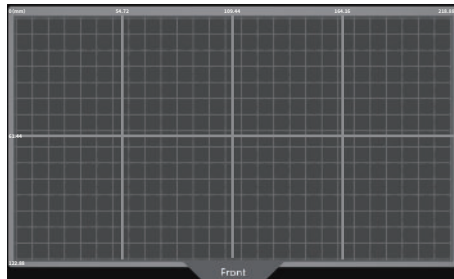

(8-Section Mode)

(Picture10)



## 1. Local Upgrade

Download the local upgrade firmware package file to a USB flash drive in advance. Insert the USB flash drive into the printer, click "Settings," then click "Version Upgrade," and select "Local Upgrade." Select the version to upgrade and click "Confirm" to start the upgrade. (See [Picture 11](#))

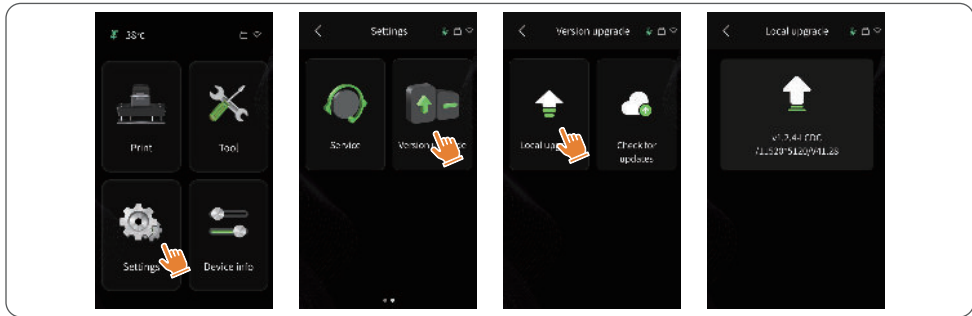

(Picture11)

## 2. Network Upgrade

When the printer is connected to the network after startup, a pop-up prompt will appear if there are firmware updates available. You can choose to upgrade the printer firmware or the camera firmware online. (See [Picture 12](#))

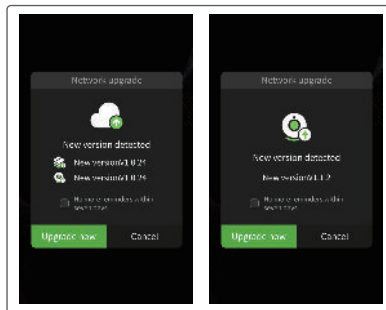

(Picture12)

### 1. Model doesn't stick to the build plate

Bottom layer exposure time is too short, please add more time.

Model bottom has very small contact with the build plate and please add more bottom layers.

### 2. Model layer breakage

Printer is shaking during printing.

Release liner film is very loose due to long-time usage and need to be changed.

Build plate or resin tank is not fastened.

### 3. Abnormal Screen Exposure

If your printer doesn't work please contact us at [3dp@elegoo.com](mailto:3dp@elegoo.com).

and as to better help and solve problems for you, please add your order ID in your email.

### 4. Printing failure

If the model was not completely printed or failed, there might be some residues left in the resin, which can be filtered out using a funnel when you save the rest resin back into its sealed bottle.

If you don't filter out the residues the build plate may cause damage to the LCD screen when you're printing next time.

As to the residual resin on the build plate and tank, you can clean and wipe them up using tissues.

### 5. Why do I receive an error message for residue detection when starting a print

First, check if the resin tank and build plate are properly secured. Then, try printing again. Avoid touching or causing vibrations to the machine during the self-check process before printing to prevent sensor calibration issues. If the error persists, clean the resin tank or filter the resin for any tiny foreign objects.

#### 6. Why do I get resin insufficient or exceeding maximum volume error when starting a print

At the beginning of the print, the mechanical sensor detects the remaining resin in the tank. To ensure smooth printing, the resin level must be above one-third of the tank volume. Additionally, the resin level should not exceed the MAX line to prevent leakage. If the required resin amount for the model exceeds the current resin level in the tank, a pop-up message will prompt for resin refilling. If you encounter abnormal errors, recalibrate the device through the self-check process. Remember not to touch or vibrate the machine during self-check to avoid affecting sensor calibration.

#### 7. How to adjust the printing speed

The release speed of the printer is fixed, with two modes available: fast and slow. However, regardless of the mode, the first 50 layers are always printed at a slower speed to ensure a higher success rate. The actual printing speed per layer also depends on the settings of the slicing parameters, such as layer thickness, exposure time, and wait time. Changing these parameters will alter the actual printing speed.

#### 8. What should I do if resin leaks into the machine

Due to the nature of tilted release motion, it is not possible to achieve a completely sealed printing area. To address this, we have implemented several protective measures. When the sensor detects resin exceeding the MAX line, the print will stop, and a pop-up window will appear as a warning. There is a groove design below the build plate, where a small amount of leaked resin can flow into without affecting the machine. However, if a significant amount of resin spills occur, please disconnect the power promptly and open the front panel of the machine for cleaning.

- Please do not use sharp or pointy tools to scrape the resin tank to avoid damaging the release liner film.
- Please clean up the resin tank before changing the resin to another color.
- Before and after printing, clean the build plate with paper towels or alcohol to ensure that there are no bumps or burrs on the build plate.
- Before each printing, daily check the exterior of the machine and all mechanical parts for any obvious damage, defects, or abnormalities.
- Try to keep the printing environment at 25-30 degrees Celsius when printing, and ventilate the printing room as much as possible to facilitate heat dissipation of the machine and resin odor volatilization.
- If the Z-axis keeps making friction noise, please add some lubricant to the lead screw. Please check and apply lubricant grease at least every 2-3 months, and increase the frequency of application as the printing frequency increases.
- If you don't use the printer in the next 48 hours, please pour the remaining resin from the resin tank back into the resin bottle and seal it well. If there is any residue, please use a filter to filter it out.
- The release film is a wearing part, please replace it regularly according to the machine prompts to ensure the success rate of printing.
- Please be careful when removing the printing platform to prevent damaging the LCD screen. The service life of the screen is about 2000+ hours and will decrease with increasing printing frequency. Do a good job of daily screen cleaning, and unplug the machine in time after printing. If there is a screen exposure problem or service life has seriously affected the print quality, please replace the screen in time.

● ELEGOO printers are covered by a warranty starting from the date of receipt. The warranty periods for different components may vary. For detailed information, please visit our official website at <https://www.elegoo.com/pages/refund-policy>.

● The free warranty does NOT include problems caused by self-disassembly and improper use, and wear and tear of the machine housing, etc.

- Telephone--0755-21005141
- Mailbox--3dp@elegoo.com
- Website--www.ELEGOO.com
- Address-- 101, No.30 Dahe Industrial Park,  
Guancheng Community, Guanhu Street,  
Longhua District, Shenzhen, China

**ELEGOO**