



## FEATURES

- ◆ AC DIMMER + FADER
- ◆ Brightness adjustment of WHITE and MONOCHROME light
- ◆ Power supply (AC IN): 230 Vac @ 50 Hz, with internal 1 A fuse
- ◆ Output (AC OUT): 230 Vac Trailing Edge (350 W max), for incandescent and halogen lamps, LED switching lamps, strip and linear LED lamps, dimmable Trailing Edge drivers
- ◆ Remote Control via BUS (DALI)
- ◆ Local Control (PUSH) via N.O. button
- ◆ Features that can be set from the Dalcnet LightApp® Mobile App:
  - Device configuration and DALI commissioning
  - Dimming curve
  - Max and min brightness levels
  - Fade-in and Fade-out time ramps
- ◆ Memory function: stores the last brightness level set
- ◆ Soft switching ON and OFF
- ◆ Extended temperature range
- ◆ Typical efficiency > 95%
- ◆ 100% Functional Test

## PRODUCT DESCRIPTION

MINI-1AC-DALI is a single-channel Alternating Current (AC) Trailing Edge dimmer, which can be connected to the 230 Vac mains power supply and is suitable for driving single-color AC loads such as incandescent and halogen lamps, LED switching lamps, LED strips/lamps and dimmable drivers in Trailing Edge mode.

MINI-1AC-DALI can be controlled via digital DALI (Digital Addressable Lighting Interface) protocol or locally via N.O. (Normally Open) button connected to the phase, neutral or as a dry contact. The type of wiring is recognized when it is turned on and the dimmer is automatically configured to work with the control connected.

The AC dimmer is equipped with an internal 1 A fuse, protecting the internal circuitry, which makes the installation of an external fuse optional. The maximum output current is 1.52 A and has the following protections: input fuse protection, output short-circuit protection, short-circuit detection, and output open-circuit detection.

Through the Dalcnet LightApp® mobile application and smartphone equipped with Near Field Communication (NFC) technology, it is possible to configure multiple parameters with the device turned off, including the adjustment curve, maximum / minimum brightness levels, fade-in / fade-out time ramps.

Dalcnet LightApp® is free to download from the Apple APP Store and Google Play Store.

→ For the up-to-date manual, please consult our website [www.dalcnet.com](http://www.dalcnet.com) or QR Code.



## PRODUCT CODE

CODE	POWER SUPPLY	OUTPUT LED	N° OUTPUT CHANNEL	REMOTE CONTROL (BUS)	LOCAL CONTROL	APP CONFIG
MINI-1AC-DALI	230 Vac @ 50 Hz	1 x 1.52 A <sup>1</sup>	1	DALI	Pushbutton N.O. <sup>2</sup>	LightApp®

Table 1: Product Code

## PROTECTIONS AND DETECTION

The following table shows the types of ingress and egress protection/detection present on the device.

ACRONYM	DESCRIPTION	TERMINAL	PRESENT
IFP	Input Fuse Protection <sup>1</sup>	AC IN	✓
SCP	Short-Circuit Protection <sup>3</sup>	AC OUT	✓
SCD	Short-Circuit Detection	AC OUT	✓
OCD	Open-Circuit Detection	AC OUT	✓

Table 2: Protection and Detection Features

## REFERENCE STANDARDS

MINI-1AC-DALI complies with the regulations listed in the following table.

NORMA	TITOLO
EN 55015	Limits and methods of measurement of radio disturbance characteristics of electrical lighting and similar equipment
EN 61547	Equipment for general lighting purposes – EMC immunity requirement <sup>4</sup>
EN 61000-3-2	Electromagnetic compatibility (EMC) – Part 3-2: Limits – Limits for harmonic current emissions (equipment input current $\leq 16$ A per phase) <sup>4</sup>
EN 61000-3-3	Electromagnetic compatibility (EMC) – Part 3-3 Limits – Limitation of voltage changes, voltage fluctuations and flicker in public low-voltage supply systems, for equipment with rated current $\leq 16$ A per phase and not subject to conditional connection <sup>4</sup>
EN 61347-1	Lamp Controlgear – Part 1: General and safety requirement
EN 61347-2-11	Lamp controlgear - Part 2-11: Particular requirements for miscellaneous electronic circuits used with luminaires
IEC 62386-101 ED2	Digital addressable lighting interface – Part 101: General requirements – System components
IEC 62386-102 ED2	Digital addressable lighting interface – Part 102: General requirements – Control gear
IEC 62386-205 ED2	Digital addressable lighting interface – Part 205: Particular requirements for control gear – Supply voltage controller for incandescent lamps (device type 4)

Table 3: Reference standards

<sup>1</sup> The maximum output current depends on the operating conditions and ambient temperature of the system. For the correct configuration, check the maximum power that can be delivered in the §[Technical specifications](#) section and in the §[Thermal Characterization](#).

<sup>2</sup> The detection of the type of wiring is done automatically.

<sup>3</sup> Short Circuit Protection (SCP) is disabled by default. It is recommended to enable this function only on compatible load types (see Table 5) on the dedicated LightApp® section.

<sup>4</sup> Compliance with EMC standards is achieved in worst-case (nominal load 200 W) by application in a suitable inlet filter.

## TECHNICAL SPECIFICATIONS

Description	Acronym	Values			Units of Measure	Note
		Min		Max		
<b>INPUT (AC IN Power)</b>						
Nominal Supply Voltage	V <sub>IN</sub>	230			Vac	-
Supply Voltage range	V <sub>IN-RNG</sub>	210	÷	240	Vac	-
Mains Frequency	f <sub>MAINS</sub>	50			Hz	-
Efficiency at full load	E <sub>FF</sub>	> 95			%	-
Standby power absorption	P <sub>STBY</sub>	< 0.5			W	-
<b>OUTPUT (AC OUT Channel)</b>						
Output Voltage	V <sub>OUT</sub>	= V <sub>IN</sub>			Vac	-
Output current <sup>5</sup> (max)	I <sub>OUT</sub>	1.52			A	-
Nominal power output	P <sub>OUT</sub>	350			W	Dependent on the type of load connected, see Table 5
Minimum load power	P <sub>MIN-LOAD</sub>	1	-	-	W	-
Load type	L <sub>TYPE</sub>	See Table 5			-	-
<b>DIMMING</b>						
Dimming curve	C <sub>DIM</sub>	Linear*		Logarithmic	-	* Available only for Local Command
Dimming method	M <sub>DIM</sub>	Trailing Edge			-	-
Dimming resolution	Res <sub>DIM</sub>	16			bit	Defined by project
Dimming range	RNG <sub>DIM</sub>	5	÷	100	%	Dependent on the type of connected load
<b>ENVIRONMENTAL</b>						
Storage Temperature	T <sub>STORE</sub>	-40	÷	+60	°C	Minimum values defined by design
Working Ambient temperature. <sup>5,6</sup>	T <sub>A</sub>	-10	÷	+60	°C	
Max Temperature @T <sub>c</sub> point	T <sub>C</sub>	-	-	+80	°C	-
Wiring Section	WS <sub>SOLID</sub>	0.05	÷	2.5	mm <sup>2</sup>	Defined by project
	WS <sub>STRAND</sub>	30	÷	12	AWG	
Strip length	WS <sub>STRIP</sub>	6,5			mm	-
Protection class	IP <sub>CODE</sub>	IP20			-	-
Enclosure Material	M <sub>CASE</sub>	Plastic			-	-
Packaging unit	UP	1			pc.	-
Mechanical dimensions	-	L	A	P		
	MD	44	57	25	mm	-
Packaging dimensions	PD	56	68	35	mm	-
Weight	W	80			g	-





Table 4: Technical specifications

<sup>5</sup> For the full range of values, refer to the §[Thermal Characterization](#) of the manual.

<sup>6</sup> Tamb<sub>max</sub>: depends on ventilation conditions

## TYPE OF LOAD

The following table shows the types of loads that can be connected to the output of the MINI-1AC-DALI.

Load	Description	Maximum Power [W]	SCP Compatibility
	Incandescent lamps / Halogen	250	✓ (< 100 W)
	Linear LED Mains Voltage Lamps	350	✓
	LED switching lamps at mains voltage	300	✓
	LED Strips / Mains Voltage LED Modules	350	✓
	Dimmable LED Trailing Edge Drivers	250	✓ (< 100 W)

Note: Short-circuit protection (SCP) is disabled by default. It is recommended that you enable this protection only on compatible loads.

Table 5: Connectable load types

## TC POINT POSITIONING

The following figure shows the positioning of the maximum temperature point (*T<sub>c</sub> point*, highlighted in red) reached by the electronics inside the enclosure. It is located on the front side (Top) near the connector of the LED outputs.



Figure 1: Location of the *T<sub>c</sub> point*

## INSTALLATION



**WARNING!** Installation and maintenance must always be carried out in the absence of voltage.

Before proceeding with the connection of the device to the 230 Vac mains, make sure that the mains voltage is disconnected from the system.



The device should only be connected and installed by qualified personnel. All applicable building regulations, legislation, rules, and codes must be complied with. Incorrect installation of the device may cause irreparable damage to the device and connected loads.

The following paragraphs show the diagrams of the connection of the dimmer to the remote control, the load and the supply voltage. It is recommended that you follow these steps to install the product safely:

- Load wiring:** connect the load to the "AC OUT" terminals respecting the technical data of the load, with the neutral of the load at the terminal with the symbol "N" and the phase at the terminal with the symbol "OUT".
- Local control wiring:** connect the N.O. button to the "IN" and "N" terminals of the "PUSH" input respecting one of the wirings shown in the connection diagram in Figure 3.
- Remote control wiring:** Connect the DA data bus signals to the "DALI" terminals with the "DA" symbols.
- Power supply wiring:** Connect the 230 Vac @ 50 Hz mains power supply to the "AC IN" terminals respecting the Live (L) and Neutral (N) convention to terminals "L" and "N" respectively.

## LOAD CONNECTION

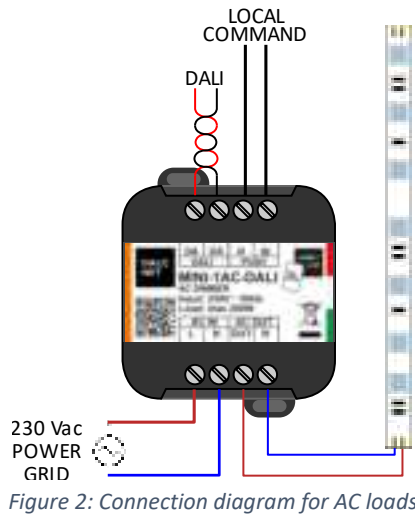

Figure 2: Connection diagram for AC loads

MINI-1AC-DALI has 1 output channel that can be driven independently (e.g. for AC modules).

The connection diagram on the side allows you to drive 1 AC load, on the AC OUT output channel.

## CONNECTING THE LOCAL COMMAND

MINI-1AC-DALI can be controlled in manual mode via N.O button.



Figure 3 shows three different wiring possibilities for the local control: N.O. switch connected as a Neutral (N) contact, connected to Live (L) or Neutral (N).

**ATTENTION!** The PUSH-N terminal is internally connected to the AC IN-N terminal, i.e. to the Neutral (N). Therefore, it is to be considered to all intents and purposes a terminal with a 230 Vac mains voltage. Before proceeding with the connection, make sure that the mains voltage is disconnected from the system.

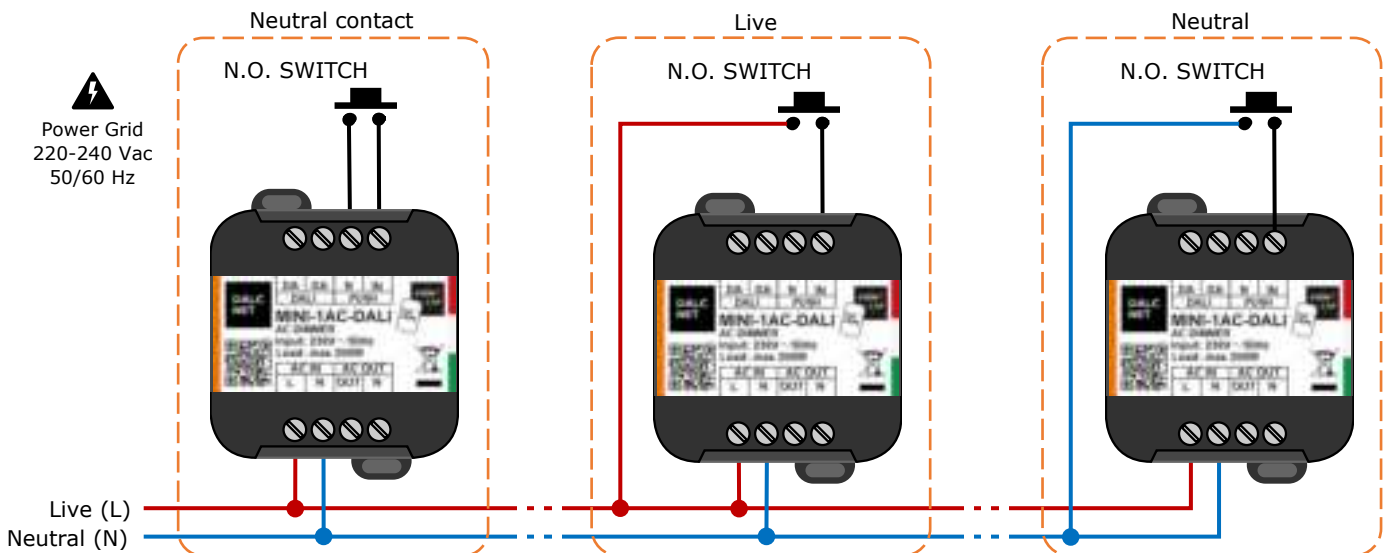



Figure 3: Local Command wiring diagram

## CONNECTING THE REMOTE CONTROL

MINI-1AC-DALI can be controlled remotely via DALI digital bus by means of a simple two-wire cable (non-twisted and unshielded). The control is carried out by means of a DALI Master that provides commands to the devices in the DALI network and, possibly, the power supply<sup>7</sup> to the network itself. DALI supports several cabling topologies, including the Bus-wiring shown as an example in Figure 4.

<sup>7</sup> Bus power can be supplied via an external 16 Vdc power supply (or within the range of 12 ÷ 20 Vdc) or by a DALI Master with integrated Bus power supply (e.g. DGM02-1248 shown in Figure 4). For more information, please consult our website: [www.dalcnet.com](http://www.dalcnet.com) ).

 To connect MINI-1AC-DALI to the DALI network, simply connect the bus cables to the "DA" terminals of the "DALI" terminal: as different topologies are possible, it is not necessary to respect the polarity of the "DA+" and "DA-" signals of the bus during connection.

**DALI CABLING TOPOLOGIES**

DALI supports several cabling topologies, such as bus cabling, shown as an example in Figure 4.

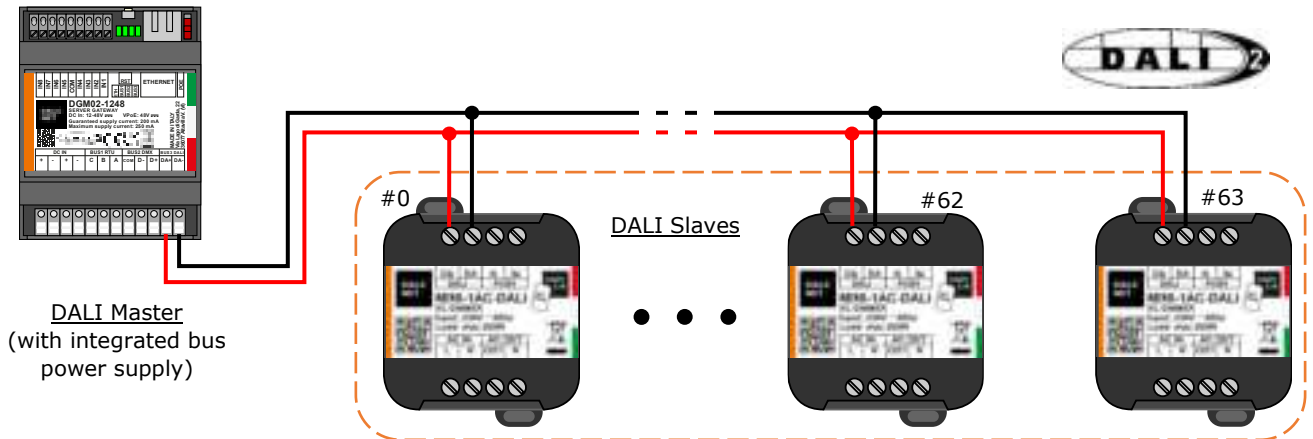

Figure 4: Remote Control Connection, Bus-wiring

The DALI-2 protocol supports up to 64 power slave devices (e.g. MINI-1AC-DALI) connected with different wiring topologies shown in Figure 5: bus, star, tree, or in-line. All other topologies are excluded.

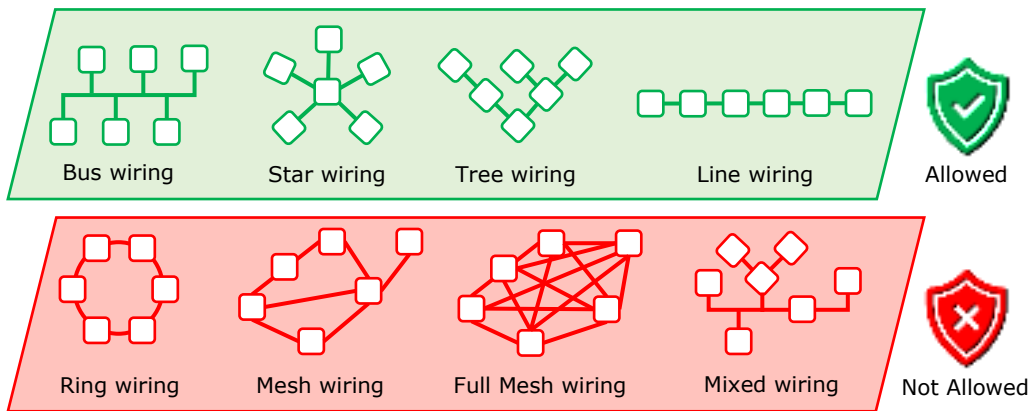



Figure 5: DALI Wiring Topologies

**POWER SUPPLY CONNECTION**

 MINI-1AC-DALI can be powered by 230 Vac @ 50Hz mains voltage and supplies the same voltage (dimmed in phase tray) to the output load. Once the load and remote control (DALI bus) are connected, connect the AC power supply respecting the Phase-Live (L) and Neutral-Neutral (N) conventions to the "L" and "N" terminals of the AC IN terminal.

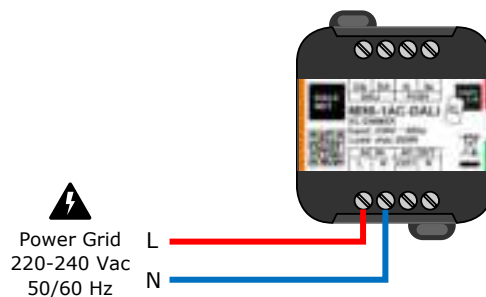

Figure 6: Power connection diagram

## LOCAL COMMAND: PUSHBUTTON

MINI-1AC-DALI has one input for N.O. pushbutton, through which different operating parameters can be managed. The connected button takes over control and adjustment of the output load: each action on the pushbutton activates a specific function listed in the following table.



ACTION	FUNCTION
 Quick press	Soft ON/OFF of the output channel
 Double quick press	Instant ON/OFF of the output channel
 Long press	Brightness adjustment (Dimming)

Table 1: Pushbutton functionality

## REMOTE CONTROL: DALI PROTOCOL

DALI (Digital Addressable Lighting Interface) is a protocol developed by the DALI Alliance (DIIA) to allow the management, configuration and programming of LED lighting systems in digital mode: through a two-way communication process between devices and control units, it is possible to execute ON, OFF or dimmer commands, report faults or information of various kinds. Based on a Master/Slave architecture, the DALI standard allows both single digital control of devices and programming in groups and/or broadcast.

In its second version, DALI-2 allows first full compatibility with the earlier protocol, and secondly brings numerous improvements compared to DALI-1:

1. Addition of lighting control devices: e.g. buttons, sensors, and LED drivers that were not included in the earlier version. In addition, to obtain DALI-2 certification, the new protocol requires the execution of functional and compliance tests by DIIA.
2. Introduction of the Multi Master architecture: with the regulation of the various lighting control devices, it is possible to send commands and signals to the DALI-2 bus from multiple sources, easing independent, immediate, and simultaneous data communication.
3. Development of functional and application standards: new extensions have been drawn up for DALI-2 devices, e.g. for emergency lighting or colour control, creating a new product standard for smart lighting and IoT systems called D4i.

### PROFILE MAPPING: OPERATION MODE

The DALI protocol provides two configurations depending on the light characteristics to be obtained through the LED module connected to the outputs. Each profile is composed of a defined number of 8-bit channels, whose values can be set in the range (0 ÷ 255), each of which stands for a light characteristic (e.g. brightness, colour, temperature, etc.) to be modulated on the LED load.

MINI-1AC-DALI supports only the DT6 profile to provide adjustment of the light intensity for the single output channel.

#### DT6 - 1 CHANNEL

The "DT6" profile allows you to adjust the light intensity for the output channel. In the §Type of Load section, it is possible to find details on the type of load and the most suitable connection diagram for this operating mode. It is understood that this profile can be used with all the other types of loads proposed in this document.

Address	Function	Level
<b>A0</b>	DIMMER 0	Level 0...255
...		
<b>A64</b>	DIMMER 64	Level 0...255

## THERMAL CHARACTERIZATION

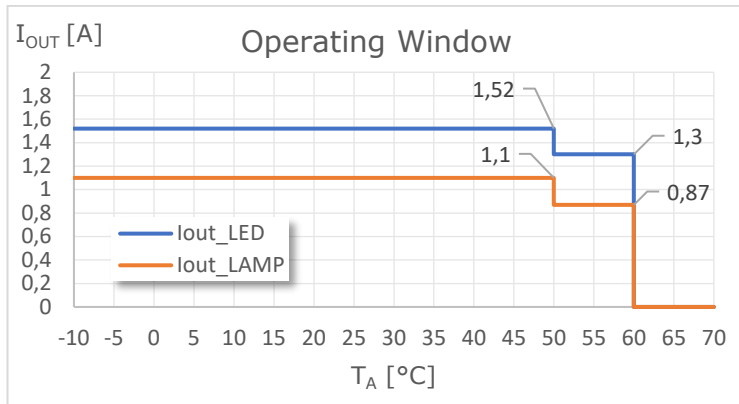

Figure 7: Temperature Operating Window

Figure 7 shows the maximum output current values that can be supplied by the MINI-1AC-DALI as a function of the operating temperature<sup>8</sup> (or ambient temperature, T<sub>A</sub>) of work, summarized below:

LOAD	TEMPERATURE (T <sub>A</sub> )	CURRENT
LED <sup>9</sup>	(-10 ÷ +50) °C	≤ 1.52 A
	(+50 ÷ +60) °C	≤ 1.3 A
LAMP <sup>10</sup>	(-10 ÷ +50) °C	≤ 1.1 A
	(+50 ÷ +60) °C	≤ 0.87 A

These maximum current values can only be applied under suitable ventilation conditions.

## DIMMING CURVES

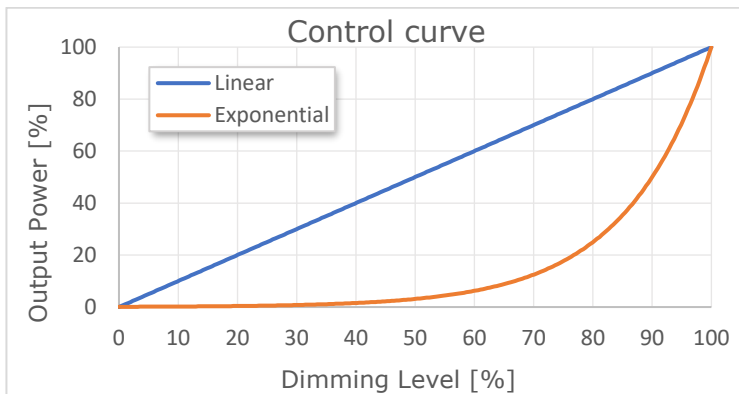

Figure 8: Dimming Curves

Figure 8 shows the dimming curves supported by the MINI-1AC-DALI. The selection of the curve can be done using the Dalcnet LightApp<sup>®</sup> app.

<sup>8</sup> In the event that the product is installed inside an electrical panel and/or junction box, T<sub>A</sub> refers to the temperature inside the panel/box.

<sup>9</sup> Referred to Linear LED Mains Voltage Lamps, LED switching lamps at mains voltage and LED Strips / Mains Voltage LED Modules load types.

<sup>10</sup> Referred to Incandescent lamps / Halogen and Dimmable LED Trailing Edge Drivers load types.



## MECHANICAL DIMENSIONS

Figure 9 details the mechanical measurements and overall dimensions [mm] of the outer casing.

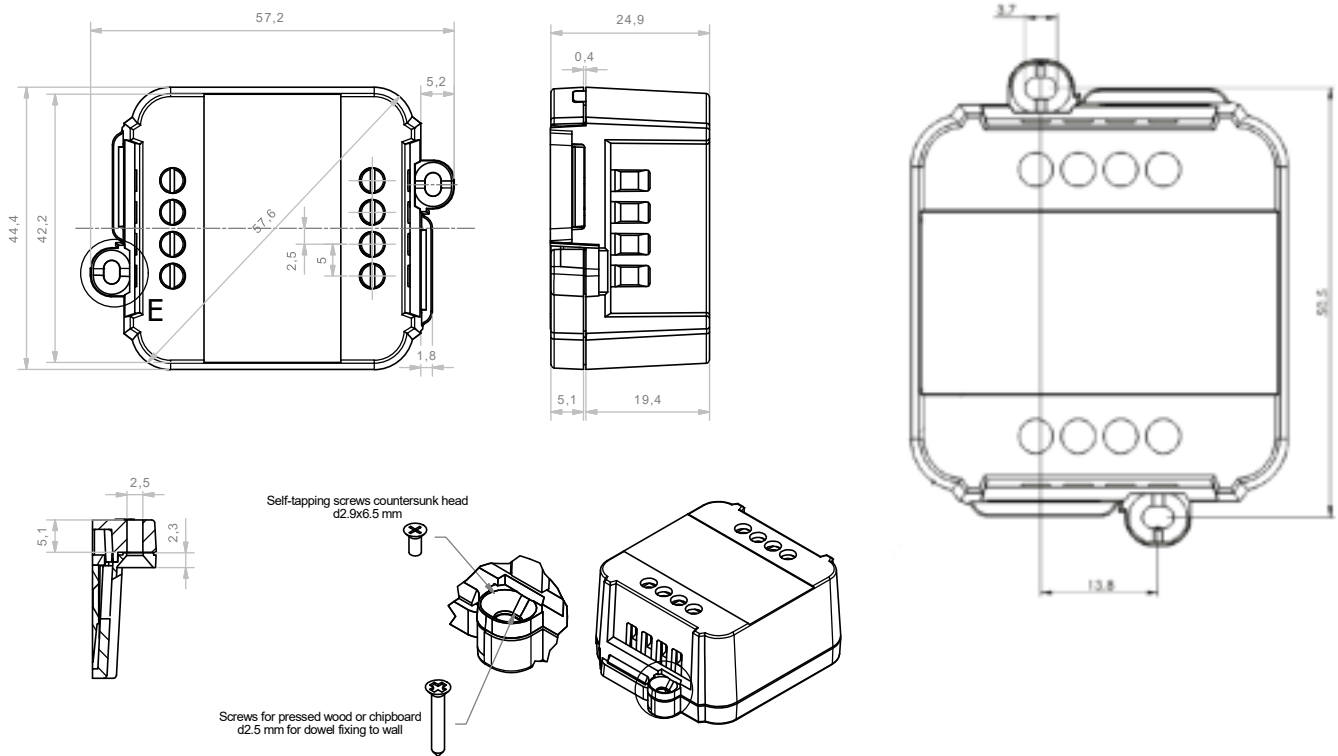

Figure 9: Mechanical dimensions

## TECHNICAL NOTES

### INSTALLATION



**WARNING!** Installation and maintenance should always be performed in the absence of AC voltage. Before proceeding with the installation, adjustment and connection of the device to the power supply, make sure that the mains voltage is disconnected from the system.



The device should only be connected and installed by qualified personnel. All applicable regulations, legislation, standards, and building codes in force in the respective countries must be adhered to. Incorrect installation of the device may cause irreparable damage to the device and connected loads.

Maintenance must only be conducted by qualified personnel in compliance with current regulations.

The product must be installed inside an electrical panel and/or junction box that is protected against overvoltage.

The external power supply must be protected. The product must be protected by a properly sized circuit breaker with overcurrent protection.

Keep 230 Vac (LV) circuits and non-SELV circuits separate from SELV safety ultra-low voltage circuits and any product connections. It is strictly forbidden to connect, for any reason, directly or indirectly, the 230 Vac mains voltage to the product (control terminals included).

The product must be installed in a vertical or horizontal position, i.e. with the faceplate/label/top cover facing up or vertically. No other positions are allowed. The bottom position, i.e. with the faceplate/label/top cover facing downwards, is not allowed.

During installation, it is recommended to reserve adequate space around the device to facilitate its accessibility in case of future maintenance or updates (e.g. via smartphone, NFC).



Use in thermally harsh environments may limit the output power of the product.

For devices embedded within luminaires, the  $T_A$  ambient temperature range is a guideline to be carefully observed for the optimal operating environment. However, the integration of the device within the luminaire must always ensure proper thermal management (e.g. correct mounting of the device, proper ventilation, etc.) so that the temperature at the  $T_C$  point does not exceed its maximum limit under any circumstances. Proper operation and durability are only guaranteed if the maximum temperature of the  $T_C$  point is not exceeded under the conditions of use.

### POWER SUPPLY AND LOAD



The device must be powered by mains voltage 230 Vac @ 50Hz. No other types of power are allowed.

Connection to an unsuitable power supply may cause the device to operate outside the specified design limits, voiding its warranty.

The power cables of the device and to the output load must be correctly sized with reference to the connected load and must be isolated from any other wiring. If a load with a high in-rush current is connected to the dimmer output, false shorts may be detected in some cases. In this case, it is recommended to disable the Short Circuit detection function.



The device has been designed to work only with Trailing Edge dimmable loads. Connecting and powering unsuitable loads may cause the device to operate outside the specified design limits, voiding its warranty. In general, the operating conditions of the device should never exceed the specifications stated in the product data sheet.

A length of the connection cables between the product and the LED module of less than 3m is recommended. Cables must be correctly sized and must be insulated from any non-SELV wiring or parts. It is recommended to use double-insulated cables. If you want to use connection cables between the product and the LED module larger than 3m, the installer must ensure the correct operation of the system. In any case, the connection between the product and the LED module must not exceed 30m.

It is not allowed to connect different types of loads in the same output channel.

Always check the compliance of the loads connected to the device. If necessary, install an EMC filter upstream of the device's power supply to mitigate in-line disturbances.

In the event of loads being connected that do not comply with the EN 61000-3-2 standard, it is the installer's obligation to ensure compliance of the entire system.

If a load with a high in-rush current is connected to the output of the dimmer, the use of an inrush current limiter is recommended.

### LOCAL COMMAND AND REMOTE CONTROL



The length of the connection cables between the local control (N.O. button or other) and the product must be less than 30m. Cables must be sized correctly. Depending on the connection used, they must be isolated from any non-SELV live wiring or parts. It is recommended to use double-insulated cables, if deemed appropriate also shielded.



It is absolutely forbidden to connect, for any reason, directly or indirectly, the 230 Vac mains voltage to the DALI terminals of the BUS.

The length and type of bus connection cables (DALI or other) must comply with the specifications of the respective protocols and the regulations in force. They must be isolated from any wiring or non-SELV live parts. It is recommended to use double-insulated cables.

All devices and control signals connected to the buses (DALI or other) must be of the SELV type (the connected devices must be SELV or in any case provide a SELV signal).

## NFC (NEAR FIELD COMMUNICATION) WARNINGS



The NFC antenna is located inside the device, the contact surface of which is indicated with the symbol . Position your smartphone so that its NFC antenna is in contact with the symbol on the device.

The location of the NFC sensor on the smartphone is dependent on the make and model of the smartphone itself. Therefore, it is recommended to refer to your smartphone's manual or the manufacturer's website to accurately determine where the NFC sensor is located. In most cases, the NFC reader is located on the back side near the top of the smartphone.

NFC technology works optimally with non-metallic materials. Therefore, it is not recommended to place the device near metal objects or reflective surfaces when using NFC.

For reliable communication, make sure that the contact surface is not covered or that it is free of metal objects, wiring, or other electronic devices. Any impediments could affect the quality of communication.

NFC technology works at a short distance, generally within a few centimeters. Make sure your device and smartphone are close enough to allow communication.

During firmware update and configuration, you should keep stable contact (possibly without movement) between your smartphone and the device for the entire duration of the process (typically between 3 and 60 seconds). This ensures that the update goes smoothly, and that the device is ready to use after the process is complete.

## LEGAL NOTES

### TERMS OF USE





Dalcnet Srl (hereinafter referred to as "the Company") reserves the right to make changes to this device, in whole or in part, without prior notice to the customer. Such changes may affect technical aspects, functionality, design, or any other element of the device. The company is not required to notify you of such changes and that your continued use of the device will constitute your acceptance of the changes.

The company is committed to ensuring that any changes do not compromise the essential functionality of the device and that they comply with applicable laws and regulations. In the event of substantial changes, the company undertakes to provide clear and timely information on the same.

The customer is advised to periodically consult the [www.dalcnet.com](http://www.dalcnet.com) website or other official sources to check for any updates or changes to the device.

## SYMBOLS

	All products are manufactured in compliance with European Regulations, as reported in the Declaration of Conformity.
	Integrated electronic ballast with double or reinforced insulation, designed to be used as a component of an end product.
	The product described in this technical data sheet at the end of its useful life is classified as waste from electronic equipment and cannot be disposed of as unsorted municipal solid waste. <b>Warning!</b> Incorrect disposal of the product may cause serious harm to the environment and human health. For correct disposal, inquire about the collection and treatment methods provided by the local authorities.

## LIGHTAPP

LIGHT  
APP

LightApp® is the official Dalcnet application through which it is possible to configure, in addition to the functions of the MINI-1AC-DALI, also all the different Dalcnet products equipped with NFC technology.

Dalcnet LightApp® is free to download from the Apple App Store and Google Play Store.



## START-UP AND FIRST INSTALLATION

### START SCREEN - CONFIGURE



On this screen, the app waits for the device parameters to be read.

To read the parameters, simply bring the back of the smartphone close to the device's label. The read-sensitive zone of the smartphone may vary depending on the model.

Once the connection is set up, a quick loading screen will appear. You must remain in position with your smartphone until the parameters are fully loaded.

iOS variant: To read the parameters, you need to press the SCAN button at the top right. A pop-up will appear showing when your smartphone is ready to scan. Move the smartphone closer to the device and remain in place until the parameters are fully loaded.

### SETTINGS

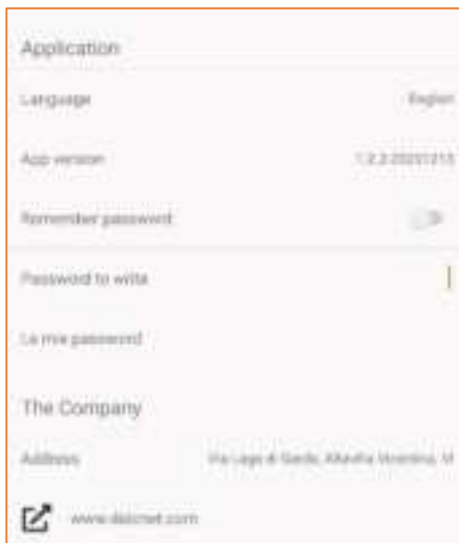

On the Settings page, you can:

- ◆ Setting the language of the app (Italian or English)
- ◆ View the app version
- ◆ Enable password saving on your smartphone
- ◆ Setting the Password for Writing Parameters
- ◆ View your saved passwords
- ◆ View the references of the distribution company (Dalcnet Srl)

## FIRMWARE



On the firmware page, you can update the firmware of your device.

The requested file must be of type *.bin*.

Once the file has been uploaded, simply follow the on-screen instructions.

### ATTENTION:

- ◆ **The upload procedure is irrevocable. Once the upload has started, it will not be possible to pause it.**
- ◆ **If the procedure is interrupted, the firmware will be corrupted, and you will need to repeat the loading procedure.**
- ◆ **At the end of the firmware load, all previously set parameters will be reset to factory defaults.**

If the update is successful and the loaded version is different from the earlier one, the device will flash 10 times on the connected load.

## LOADING PARAMETERS

**IMPORTANT: The parameters must be written when the device is switched OFF (without input power).**

### READ



With the app in READ mode, the smartphone will scan the device and show its current configuration on the screen.

### WRITE

In WRITE mode, the smartphone will write the parameter configuration set on the screen to the device.



In normal mode (*Write All* switched OFF) the app writes only the parameters that have changed since the previous read. In this mode, the write will only be successful if the serial number of the device matches the one previously read.

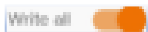

In *Write All* mode, all parameters are written. In this mode, the write will only be successful if the device model matches the one previously read.

**It is recommended to activate the *Write All* mode only when you need to replicate the same configuration on many examples of the same model.**

### WRITE PROTECTION



By the padlock button it is possible to set a lock when writing parameters. A screen will appear for entering a 4-character password. Once this password has been written into the device, all next parameter changes can only be made if the correct password is written on the app's Settings page.

To remove the password lock, simply press the lock key and leave the Password field blank.

## WRITE ERROR

After writing the parameters, if the load connected to the device flashes continuously at a frequency of 2 times per second when it is turned ON again, it means that the writing was not successful. Therefore, you will need to perform the following steps:

1. Turn OFF the device.
2. Perform a parameter rewrite.
3. Wait for the write to be successful or for no error messages to appear.
4. Turn the device back ON.

If that doesn't work, you can perform a factory reset by quickly turning the device OFF and ON 6 times.

## PRODUCT INFORMATION



On the *Product Information* screen, you can view a variety of information about the product you are about to configure.

**Product Name:** User-settable field for easy identification (e.g. Office, Meeting Room, Lobby, etc.). By default, the product name is the same as the Model field.

**Model:** the model of the device (non-editable field).

**Serial Number:** uniquely identifies the device (non-editable field).

**Firmware Version:** shows the firmware version currently loaded on the device (non-editable field).

## CONTROL SETTINGS

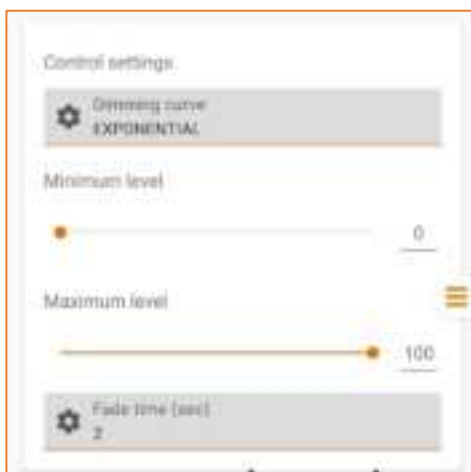

On the *Control Settings* screen, you can configure the different parameters for the Local Command mode of operation.

**Dimming curve:** Sets the adjustment curve of the device for operation with local control. For details on the different curves that can be set, see the §Dimming Curves section of this manual.

**Minimum Level:** sets the minimum level of light intensity that can be reached by local control.

**Maximum Level:** sets the maximum level of light intensity that can be achieved by local control.

**Fade time:** The time in seconds [s] that the output takes to make a transition from one light intensity level to another.

## CONTROL TYPE

The PUSH-ON OFF DIM *control type* allows switching on/off and dimming via N.O. switch in the manner described in the §Local Command: pushbutton paragraph. Below are the parameters that can be set for the local command.



**Power-On level:** this is the intensity value to which the output is brought as soon as the device is powered.

**Last Level:** Enables the memory function. The Power On level will be the last level assumed before the power supply was removed.

**Push-On level:** this is the intensity value to which the output is brought when the device is accessed by means of a button.

**Last Level:** Enable the memory function. The power level will correspond to the last level assumed before the device was turned off by the button.

**Dimming speed:** This is the time it takes to adjust the light from 100% to 0% and vice versa.

**Double-push delay:** Allows you to set the speed at which you need to perform the quick double press.

## DALI PARAMETERS

Through LightApp® it is possible to set the following functions as shown in a reduced version in the image.



**DALI Firmware:** Identifies the DALI firmware version currently loaded on the device (non-editable field).

**GTIN:** unique DALI code of the product (non-editable field).

**Identification Number:** Serial number of the microcontroller (field cannot be modified).

**Open Circuit Detection:** Enables or disables output open-circuit detection (refer to §Open Circuit and Short Circuit Detection).

**Short-Circuit Detection:** Enables or disables output short-circuit detection (refer to §Open Circuit and Short Circuit Detection).

**Adjustment Curve:** Sets the adjustment curve of the device for operation with remote control. For details on the different curves that can be set, see the §

Dimming Curves of this manual.

**PHM:** Indicates whether the switched-on device is only switching (PHM=254) or dimmable (PHM<254) (field cannot be changed).

**DALI Address:** The address associated with the device in the DALI network.



**Minimum Level:** sets the minimum level of light intensity that can be reached by remote control (default value = 1).

**Maximum Level:** sets the maximum level of light intensity that can be reached by remote control (default value = 254).

**Power-On level:** this is the intensity value to which the output is brought as soon as the device is powered.

**Mask:** Enables or disables the audit.

**System Failure Level:** this is the intensity value to which the output is brought when a system failure occurs.

**Mask:** Enables or disables the audit.

**Fade rate:** indicates the rate (in steps/second) at which the output changes in brightness when the UP and DOWN commands are received.

**Fade time:** allows you to set the time it takes for the output to make a transition from one level of light intensity to another.

**Group 0-15:** allows you to associate the device address with one or more groups.

**Mask:** Enables or disables the audit.

**Scene 0-15:** allows you to associate the device with one or more scenes.

**Mask:** Enables or disables the audit.

## OPEN CIRCUIT AND SHORT CIRCUIT DETECTION

Using the Lamp-Failure command, the DALI protocol allows you to detect situations where the LED load connected to the output of the MINI-1AC-DALI may not work as expected, such as an incorrect connection (detecting it as an Open Circuit error) or a defect in the LED load (detecting it as a short circuit).



### Enable/Disable Open Circuit Function:

If a very small load is connected to the dimmer output, false open circuits may be detected in some cases. In this case, it is recommended to disable the Open Circuit detection function.

### Enable/Disable Short Circuit Function:

If a load with a high in-rush current is connected to the dimmer output, false shorts may be detected in some cases. In this case, it is recommended to disable the Short Circuit detection function.