

Contents

1	Instructions	4
1.1	General safety instructions	4
1.2	Identification plate	8
1.3	Manufacturer liability	9
1.4	Appliance purpose	9
1.5	This user manual	9
1.6	How to read the user manual	9
1.7	To save energy	10
2	Description	11
2.1	General Description	11
2.2	Cooktop	12
2.3	Control panel	12
2.4	Other parts	13
2.5	Available accessories	13
3	Use	15
3.1	First use	16
3.2	Using the accessories	17
3.3	Using the cooktop	18
3.4	Using the storage compartment	19
3.5	Using the oven	19
3.6	Cooking advice	20
3.7	Programmer clock	21
4	Cleaning and maintenance	27
4.1	Cleaning the appliance	27
4.2	Removing the door	28
4.3	Cleaning the door glazing	29
4.4	Removing the internal glass panes	29
4.5	Vapour Clean	31
4.6	Extraordinary maintenance	32
5	Installation	35
5.1	Minimum clearance to combustible surfaces	35
5.2	Gas connection	35
5.3	Adaptation to different types of gas	38
5.4	Positioning	39
5.5	Electrical connection	45
5.6	For the installer	46

We advise you to read this manual carefully, which contains all the instructions for maintaining the appliance's aesthetic and functional qualities.

For further information on the product: www.smeg.com



1 Instructions

1.1 General safety instructions

Risk of personal injury

- During use the appliance becomes hot. Care should be taken to avoid touching heating elements inside the oven.
- Protect your hands by wearing oven gloves when handling food inside the oven cavity.
- Never try to put out a fire or flames with water: turn off the appliance and smother the flames with a fire blanket or other appropriate cover.
- The appliance is not intended for use by persons (including children) with reduced physical, sensory or mental capabilities, or lack of experience and knowledge, unless they have been given supervised or instruction concerning use of the appliance by a responsible person for their safety.
- Young children should be supervised to ensure that they do not play with the appliance.
- Keep children under eight years of age at a safe distance if they are not constantly supervised.
- Do not allow children younger than 8 years old to come near the appliance when in operation.
- Young children should be supervised to ensure that they do not play with the appliance.
- During use the appliance becomes hot. Care should be taken to avoid touching heating elements inside the oven.
- **WARNING:** Ensure the appliance is switched off before replacing the lamp to avoid the possibility of electric shock.
- **WARNING - Accessible parts will become hot when in use.** To avoid burns young children should be kept away.
- **Danger of fire – Do not store items on the cooking surface.**
- **CAUTION – The cooking process has to be supervised.** A short term cooking process has to be supervised continuously.
- **Warning – Unattended cooking on a hob with fat or oil can be dangerous and may result in a fire.**
- This appliance is not intended to be operated by means of external timer or separate remote control system.
- Cleaning and maintenance must not be carried out by unsupervised children.
- Make sure that the flame-spreader crowns are correctly positioned in



their housings with their respective burner caps.

- Be aware of how rapidly the cooking zones heat up. Do not place empty pans on the heat. Danger of overheating.
- Fats and oils can catch fire if they overheat. Do not leave the appliance unattended while preparing foods containing oils or fats. If fats or oils catch fire, never put water on them. Place the lid on the pan and turn off the relevant cooking zone.
- The cooking process must always be monitored. Short cooking processes must be monitored continuously.
- When in use, do not place metal objects, such as dishes or cutlery, on the surface of the cooktop as they may overheat.
- Do not insert pointed metal objects (cutlery or utensils) into the slots in the appliance.
- Do not pour water directly onto very hot trays.
- Keep the oven door closed during cooking.
- If you need to move food or at the end of cooking, open the door 5 cm for a few seconds, let the steam come out, then open it fully.
- Do not open the storage compartment (if present) when the oven is on and still hot.
- The items inside the storage compartment could be very hot after the oven has been used.
- **DO NOT USE OR STORE FLAMMABLE MATERIALS IN THE APPLIANCE STORAGE DRAWER OR NEAR THIS APPLIANCE.**
- **DO NOT SPRAY AEROSOLS IN THE VICINITY OF THIS APPLIANCE WHILE IT IS IN OPERATION.**
- Switch the appliance off immediately after use.
- **DO NOT MODIFY THIS APPLIANCE.**
- Before carrying out any work on the appliance (installation, maintenance, positioning or moving), wear personal protective equipment.
- Before carrying out any work on the appliance, disconnect the mains power supply.
- Have authorised persons carry out installation and assistance interventions according to the standards in force.
- Do not try to repair the appliance yourself or without the intervention of authorised persons.
- Do not pull the cable to remove the plug.



Instructions

- If the power supply cable is damaged, contact technical support immediately and they will replace it.

Risk of damaging the appliance

- Do not use abrasive or corrosive detergents (e.g. scouring powders, stain removers and metallic sponges) on glass parts.
- Use wooden or plastic utensils.
- Racks and trays must be inserted as far as they will go into the side guides. The mechanical safety locks that prevent them from being removed must face downwards and towards the back of the oven cavity.
- Do not seat on the appliance.
- Do not use a steam cleaner to clean the appliance.
- Do not obstruct ventilation openings and heat dispersal slots.
- Never leave the appliance unattended during cooking operations in which fats or oils could be released that could overheat and catch fire. Be very careful.
- Do not use a steam cleaner to clean this appliance.
- Do not use harsh abrasive cleaners or sharp metal scrapers to clean the oven glass door since they can scratch the surface, which

may result in shattering of the glass.

- Never leave objects on the cooking surface.
- DO NOT USE THE APPLIANCE AS A SPACE HEATER.
- DO NOT PLACE ARTICLES ON OR AGAINST THIS APPLIANCE.
- Do not spray any spray products near the oven.
- Do not use plastic kitchenware or containers when cooking food.
- Do not put sealed tins or containers in the oven.
- Remove all trays and racks which are not required during cooking.
- Do not cover the bottom of the oven cavity with aluminium or tin foil sheets.
- Do not place pans or trays directly on the bottom of the oven cavity.
- If you wish to use greaseproof paper, place it so that it will not interfere with the hot air circulation inside the oven.
- Do not use the open door to rest pans or trays on the internal glass panel.
- The cooking vessels or griddle plates should be placed inside the perimeter of the cooktop.
- All cookware must have smooth, flat bottoms.



- If any liquid does boil over or spill, remove the excess from the cooktop.
- Take care not to spill acidic substances such as lemon juice or vinegar onto the cooktop.
- Do not put empty pans or frying pans on switched on cooking zones.
- Do not use steam jets to clean the appliance.
- Do not use rough or abrasive materials or sharp metal scrapers.
- Do not use cleaning products containing chlorine, ammonia or bleach on steel parts or parts with metallic surface finishes (e.g. anodizing, nickel- or chromium-plating).
- Do not use abrasive or corrosive detergents (e.g. scouring powders, stain removers and metallic sponges) on glass parts.
- Do not wash the removable components such as the cooktop pan stands, flame-spreader crowns and burner caps in a dishwasher.
- Never use the oven door to lever the appliance into place when fitting.
- Avoid exerting too much pressure on the oven door when open.
- Do not use the handle to lift or

move the appliance.

- NOT SUITABLE WITH AFTERMARKET LIDS OR COVERS.

Installation

- THIS APPLIANCE **MUST NOT BE INSTALLED** IN BOATS OR CARAVANS.
- If this appliance is installed on a base, measures must be taken to prevent the appliance from slipping from the base.
- The appliance must not be installed on a stand.
- Position the appliance into the cabinet cutout with the help of a second person.
- This appliance must not be installed behind a decorative door.
- The gas connection should be carried out by authorised persons.
- Installation with flexible hose must be carried out so that the length of the piping does not exceed 2 metres when fully extended as regards flexible steel hoses and 1.2 metres in case of rubber hoses.
- The hoses should not come into contact with moving parts and should not be crushed in any way.
- Use a pressure regulator that complies with current regulations.
- After carrying out any operation,



Instructions

check that the tightening torque of gas connections is between 10 Nm and 15 Nm.

- At the end of the installation, check for any leaks with a soapy solution, never with a flame.
- Have the electrical connection performed by authorised persons.
- The appliance must be connected to earth in compliance with electrical system safety standards.
- If the electrical supply is restricted, means of allpole disconnection must be accessible and incorporated in the fixed wiring in accordance with the wiring rules.
- If this cooking range is to be connected to a new or upgraded electrical installation, then it must be connected by a supply cord fitted with: 1) An appropriate rated plug that is compatible with the socket-outlet fitted to the final sub circuit in the fixed wiring that supplies this cooker. 2) An appropriate rated installation male connector that is compatible with the installation female connector fitted to the final sub-circuit in the fixed wiring that supplies the cooker.
- Use cables withstanding a temperature of at least 90°C.
- The tightening torque of the screws of the terminal supply wires must

be 1.5 - 2 Nm.

- If this appliance is installed on a base, measures must be taken to prevent the appliance from slipping from the base.

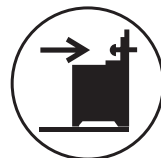

For this appliance

- Ensure that the appliance is switched off before replacing the bulb.
- This appliance is not intended to be operated by means of external timer or separate remote control system
- Do not rest any weight or sit on the open door of the appliance.
- Take care that no objects are stuck in the doors.

1.2 Identification plate

- The identification plate bears the technical data, serial number and brand name of the appliance. Do not remove the identification plate for any reason.
- Place the supplied data plate to a suitable adjacent surface or within the instruction manual for future reference.



1.3 Manufacturer liability

The manufacturer declines all liability for damage to persons or property caused by:

- use of the appliance other than the one envisaged;
- non-observance of the user manual provisions;
- tampering with any part of the appliance;
- use of non-original spare parts.

1.4 Appliance purpose

- This appliance is intended for cooking food in the home environment. Every other use is considered improper.
- The appliance is not designed to operate with external timers or with remote-control systems.

1.5 This user manual

This user manual is an integral part of the appliance and must therefore be kept in its entirety and in an accessible place for the whole working life of the appliance. Read this user manual carefully before using the appliance.

1.6 How to read the user manual

This user manual uses the following reading conventions:

Instructions



General information on this user manual, on safety and final disposal.

Description



Description of the appliance and its accessories.

Use



Information on the use of the appliance and its accessories, cooking advice.

Cleaning and maintenance



Information for proper cleaning and maintenance of the appliance.

Installation



Information for authorised persons: installation, operation and inspection.



Safety instructions



Information



Advice

1. Sequence of instructions for use.

- Standalone instruction.



1.7 To save energy

- Only preheat the appliance if the recipe requires you to do so.
- Unless otherwise indicated on the package, defrost frozen foods before placing them in the oven.
- When cooking several types of food it is recommended to cook the foods one after the other to make the best use of the already hot oven.
- Use dark metal moulds: They help to absorb the heat better.
- Remove all trays and racks which are not required during cooking.
- Stop cooking a few minutes before the time normally used. Cooking will continue for the remaining minutes with the heat which has accumulated inside the oven.
- Reduce any opening of the door to a minimum to avoid heat dispersal.
- Keep the inside of the oven clean at all times.



2 Description

2.1 General Description

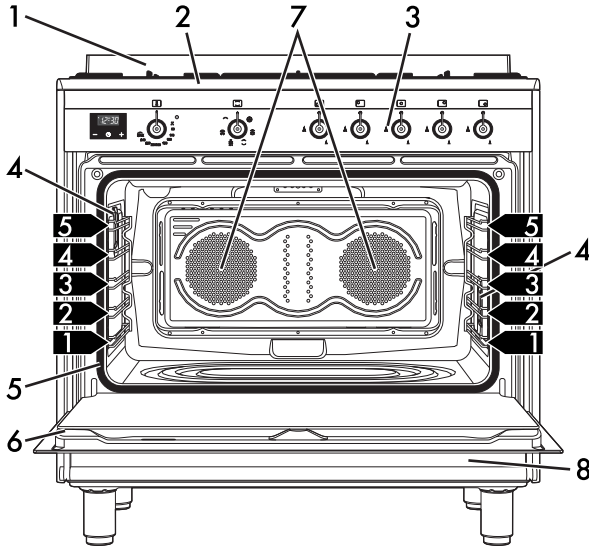

- 1 Backguard
- 2 Cooktop
- 3 Control panel
- 4 Oven light
- 5 Seal

- 6 Door
- 7 Fan
- 8 Storage compartment
- 1,2,3** Rack/tray support frame shelf



Description

2.2 Cooktop

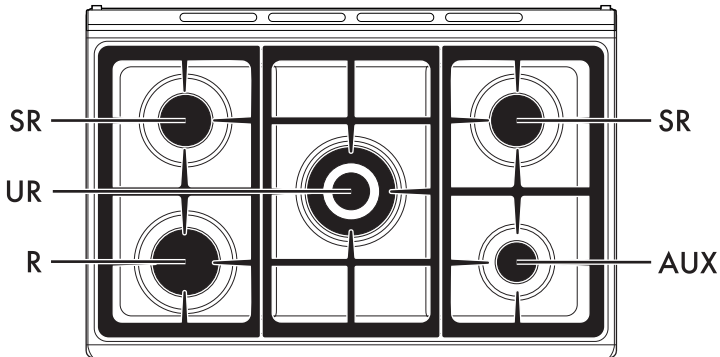

AUX = Auxiliary
SR = Semi-rapid

R = Rapid
UR = Ultra-rapid

2.3 Control panel

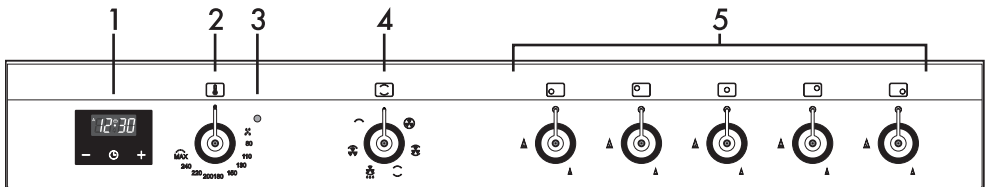

1 Programmer clock

Useful for displaying the current time, setting programmed cooking operations and programming the minute minder timer.

2 Temperature knob

This knob allows you to select the cooking temperature.

Turn the knob clockwise to the required value, between the minimum and maximum setting.

3 Indicator light

The indicator light comes on to indicate that the oven is heating up. It turns off as soon as it reaches the set temperature. It flashes regularly to indicate that the temperature set inside the oven is kept constant.

3 Function knob



The oven's various functions are suitable for different cooking modes. After selecting the required function, set the cooking temperature using the temperature knob.



5 Cooktop burner knobs

Useful for lighting and adjusting the cooktop burners.

Press and turn the knobs anti-clockwise to the value  to light the relative burners.

Turn the knobs to the zone between the maximum  and minimum  setting to adjust the flame.

Return the knobs to the  position to turn off the burners.

2.4 Other parts

Shelves

The appliance features shelves for positioning trays and racks at different heights. The insertion heights are indicated from the bottom upwards (see 2.1 General Description).

Cooling fan

The fan cools the oven and comes into operation during cooking.

The fan causes a steady outflow of air from above the door which may continue for a brief period of time even after the appliance has been turned off.

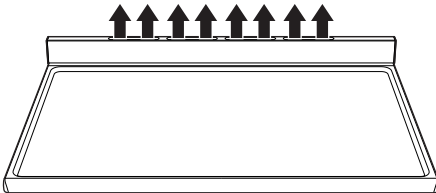

Do not obstruct ventilation openings and heat dispersal slots.

Interior lighting

The appliance interior lighting comes on:

- When the door is opened
- When any function is selected.

2.5 Available accessories



Some models are not provided with all accessories.

Ring reducer

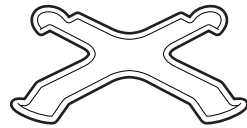

Useful when using small cookware.

WOK ring

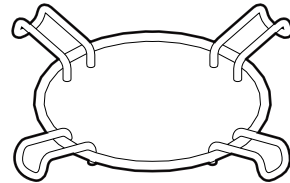

Useful when using a wok.



Description

Rack

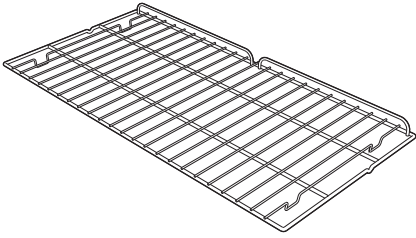

Useful for supporting containers with food during cooking.

Oven tray

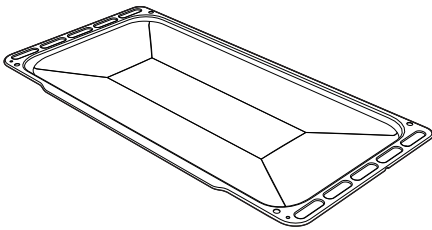

Useful for collecting fat from foods placed on the rack above.

Deep tray

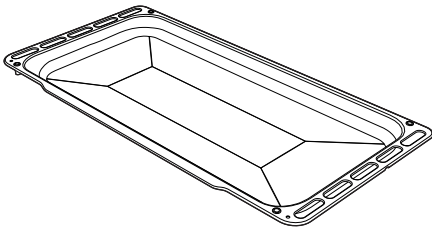

Useful for collecting fat from foods placed on the rack above and for cooking pies, pizzas and baked desserts.



The accessories intended to come into contact with food are made of materials that comply with the provisions of current legislation.



Supplied and optional accessories can be requested to Authorised Assistance Centres. Use only original accessories supplied by the manufacturer.



3 Use

Instructions



High temperature inside the oven during use Danger of burns

- Keep the oven door closed during cooking.
- Protect your hands wearing heat resistant gloves when moving food inside the oven.
- Do not touch the heating elements inside the oven.
- Do not pour water directly onto very hot trays.
- Do not allow children younger than 8 years old to come near the appliance when in operation.
- If you need to move food or at the end of cooking, open the door 5 cm for a few seconds, let the steam come out, then open it fully.



Improper use Danger of burns

- Make sure that the flame-spreader crowns are correctly positioned in their housings with their respective burner caps.
- Oils and fat could catch fire if overheated. Be very careful.



Improper use Risk of damage to surfaces

- Do not cover the bottom of the oven cavity with aluminium or tin foil sheets.
- If you wish to use greaseproof paper, place it so that it will not interfere with the hot air circulation inside the oven.
- Do not place pans or trays directly on the bottom of the oven cavity.
- Do not use the open door to rest pans or trays on the internal glass pane.
- Do not pour water directly onto very hot trays.
- Make sure that the flame-spreader crowns are correctly positioned in their housings with their respective burner caps.
- The cooking vessels or griddle plates should be placed inside the perimeter of the cooktop.
- All pans must have smooth, flat bottoms.
- If any liquid does boil over or spill, remove the excess from the cooktop.



High temperature inside the storage compartment Danger of burns

- Do not open the storage compartment when the oven is on and still hot.
- The items inside the storage compartment could be very hot after using the oven.



High temperature inside the oven during use

Danger of fire or explosion

- Do not spray any spray products near the oven.
- Do not use or leave flammable materials near the oven or the storage compartment.
- Do not use plastic kitchenware or containers when cooking food.
- Do not put sealed tins or containers in the oven.
- Do not leave the oven unattended during cooking operations where fats or oils could be released.
- Remove all trays and racks which are not required during cooking.

Escaping gas may cause an explosion.

If you smell gas or notice any faults in the gas installation:

- Immediately shut off the gas supply or close the gas cylinder valve.
- Immediately extinguish all naked flames and cigarettes.
- Do not use any light or appliance switches and do not pull any plugs out of sockets. Do not use any telephones or mobile phones within the building.
- Open windows and ventilate the room.
- Call the aftersales service or the gas supplier.

Abnormal operation

Any of the following are considered to be abnormal operation and may require service:

- Yellow tipping of the hotplate burner flame.
- Sooting up of cooking utensils.
- Burners not igniting properly.
- Burners failing to remain alight.
- Burners extinguishing whilst in operation.
- Gas valves which are difficult to turn.

In case the appliance fails to operate correctly, contact the Authorised Assistance Centre in your area.

3.1 First use

1. Remove any protective film from the outside or inside of the appliance, including accessories.
2. Remove any labels (apart from the technical data plate) from the accessories and from the oven cavity.
3. Remove all the accessories from the appliance and clean them (see 4 Cleaning and maintenance). Heat the empty oven at the maximum temperature to burn off any residues left by the manufacturing process.



3.2 Using the accessories

Racks and trays

Racks and trays have to be inserted into the side guides until they come to a complete stop.

- The mechanical safety locks that prevent the rack from being taken out accidentally have to face downwards and towards the oven back.

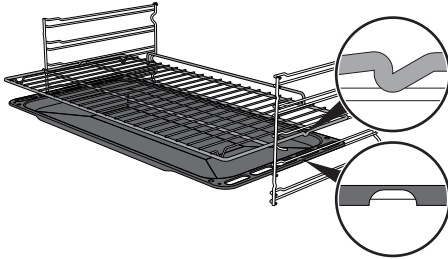

Gently insert racks and trays into the oven until they come to a stop.



Clean the trays before using them for the first time to remove any residues left by the manufacturing process.

Ring reducers

The ring reducers have to be placed on the cooktop grids. Make sure they are placed properly.

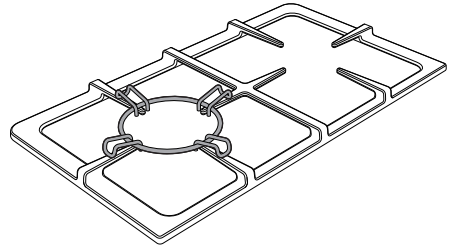
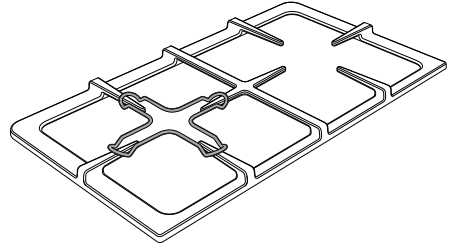



3.3 Using the cooktop

All the appliance's control and monitoring devices are located together on the front panel. The burner controlled by each knob is shown next to the knob. The appliance is equipped with an electronic ignition device. Simply press the knob and turn it anti-clockwise to the maximum flame symbol, until the burner lights. If the burner does not light in the first 15 seconds, turn the knob to

 and wait 60 seconds before trying again. After lighting, keep the knob pressed in for a few seconds to allow the thermocouple to heat up. The burner may go out when the knob is released: in this case, the thermocouple has not heated up sufficiently. Wait a few moments and repeat the operation. Keep the knob pressed in longer.



In case of an accidental switching off, a safety device will be tripped, cutting off the gas supply, even if the gas cock is open. Return the knob to  and wait at least 60 seconds before lighting it again.

Correct positioning of the flame-spreader crowns and burner caps

Before lighting the cooktop burners, make sure that the flame-spreader crowns are correctly positioned in their housings with their respective burner caps. Make sure that the holes in the flame-spreader crowns **1** are aligned with the thermocouples **2** and igniters **3**.

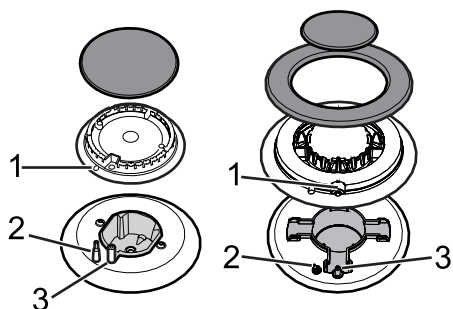

Practical tips for using the cooktop

For better burner efficiency and to minimise gas consumption, use pans with lids and of suitable size for the burner, so that flames do not reach up the sides of the pan. Once the contents come to the boil, turn down the flame far enough to ensure that the liquid does not boil over.



Cookware diameters:

- Auxiliary: 12 - 14 cm.
- Semi-rapid: 16 - 24 cm.
- Rapid: 18 - 26 cm.
- Ultra-rapid: 18 - 28 cm.



3.4 Using the storage compartment

The storage compartment is at the bottom of the cooker. To open it, pull the handle towards you. It can be used to store cookware or metallic objects necessary when using the appliance.

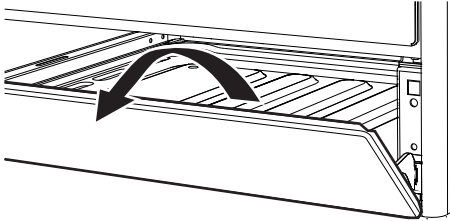

3.5 Using the oven

Switching on the oven

To switch on the oven:

1. Select the cooking function using the function knob.
2. Select the temperature using the temperature knob.

Preheating stage

Cooking functions are always preceded by a preheating stage, which allows the appliance to heat up to cooking temperature.

The indicator light comes on to indicate that the oven is heating up.

The indicator light turns off to indicate that the food can be placed inside the oven and cooking will start automatically.

Functions list



Fan forced

The combination of the fan and the circular heating element (incorporated in the rear of the oven) allows you to cook different foods on several levels, as long as they need the same temperatures and same type of cooking. Hot air circulation ensures instant and even distribution of heat. It will be possible, for instance, to cook fish, vegetables and biscuits simultaneously (on different levels) without odours and flavours mingling.



Fan assisted

The operation of the fan, combined with traditional cooking, ensures consistent cooking even with complex recipes. Perfect for biscuits and cakes, even when simultaneously cooked on several levels. (For multiple-level cooking, we recommend using the 2nd and 4th shelf).



Convection

As the heat comes from above and below at the same time, this system is particularly suitable for certain types of food. Traditional cooking, also known as convection cooking, is suitable for cooking just one dish at a time. Perfect for all types of roasts, bread and cakes, and in any case, particularly suitable for fatty meats such as goose and duck.



Baker's function

The combination of the fan with just the lower heating element allows cooking to be completed more rapidly. This system is recommended for sterilising or for finishing off the cooking of foods which are already well-cooked on the surface, but not inside, which therefore need a little more heat. Perfect for any type of food.



Fan grill

The air produced by the fan softens the strong heatwave generated by the grill, grilling perfectly even very thick foods. Perfect for large cuts of meat (e.g. pork hock).



Grill

The heat coming from the grill element gives perfect grilling results above all for thin and medium thickness meat and, in combination with the rotisserie (where fitted), gives the food an even browning at the end of cooking. Perfect for sausages, spare ribs and bacon. This function enables large quantities of food, particularly meat, to be grilled evenly.



Vapour Clean

This function makes cleaning easier using the steam produced by a small quantity of water poured onto the appropriate groove placed on the bottom.



3.6 Cooking advice

General advice

- Use a fan assisted function to achieve consistent cooking at several levels.
- It is not possible to shorten cooking times by increasing the temperature (the food could be overcooked on the outside and undercooked on the inside).

Advice for cooking meat

- Cooking times vary according to the thickness and quality of the food and to consumer taste.
- Use a meat thermometer when roasting meat, or simply press on the roast with a spoon. If it is hard, it is ready; if not, it needs another few minutes cooking.

Advice for cooking with the Grill and the Fan grill

- Meat can be grilled even when it is put into the cold oven or into the preheated oven if you wish to change the effect of the cooking.
- With the Fan grill function, we recommend that you preheat the oven before grilling.
- We recommend placing the food at the centre of the rack.
- With the Grill function, we recommend that you turn the temperature knob to the maximum value near the  symbol to optimise cooking.
- Foods should be seasoned before cooking. Foods should also be coated with oil or melted butter before cooking.
- Use the oven tray on the first bottom shelf to collect fluids produced by grilling.
- Grilling processes should never last more than 60 minutes.



Advice for cooking desserts/pastries and biscuits

- Use dark metal moulds: they help to absorb the heat better.
- The temperature and the cooking time depend on the quality and consistency of the dough.
- To check whether the dessert is cooked right through: at the end of the cooking time, put a toothpick into the highest point of the dessert. If the dough does not stick to the toothpick, the dessert is cooked.
- If the dessert collapses when it comes out of the oven, on the next occasion reduce the set temperature by about 10°C, selecting a longer cooking time if necessary.
- While cooking desserts or vegetables, excessive condensation may form on the glass. In order to avoid this, open the door very carefully a couple of times while cooking.

Advice for defrosting and proving

- Place frozen foods without their packaging in a lidless container on the first shelf of the oven.
- Avoid overlapping the food.
- To defrost meat, use the rack placed on the second level and a tray on the first level. In this way, the liquid from the defrosting food drains away from the food.
- The most delicate parts can be covered with aluminium foil.
- For successful proving, a container of water should be placed in the bottom of the oven.



3.7 Programmer clock



 Value decrease key

 Clock key

 Increase key

 Ensure that the programmer clock shows the cooking duration symbol  , otherwise it will not be possible to turn on the oven. Press the key  to reset the programmer clock.







Use

Setting the time





If the time is not set, the oven will not switch on.

On the first use, or after a power failure, the digits  will be flashing on the appliance's display.

1. Hold down the clock key  for two seconds. The dot between the hours and the minutes flashes.
2. The time can be set via the value increase key  and value decrease key . Keep the key pressed in to increase or decrease rapidly.
3. Wait 7 seconds. The dot between the hours and the minutes stops flashing.
4. The symbol  on the display indicates that the appliance is ready to start cooking.













To change the time, hold down the value increase key  and value decrease key  at the same time for two seconds, then set the time.

Timed cooking







Timed cooking is the function which allows a cooking operation to be started and then ended after a specific length of time set by the user.

1. Keep the clock key  pressed until the symbol  appears.
 2. Press the clock key  again. On the display the symbol  and the text  appear, alternating with the current time.
 3. Use the value increase  and value decrease  keys to set the required minutes of cooking.
 4. Select a function and a cooking temperature.
 5. Wait approx. 5 seconds without pressing any key in order for the function to activate. The current time and the symbols  and  will appear on the display.
- At the end of cooking the heating elements will be deactivated. On the display, the symbol  turns off, the symbol  flashes and the buzzer sounds.
6. To turn the buzzer off, simply press one of the programmer clock keys.









- Press the clock key  to reset the programmer clock.







 It is not possible to set a cooking time of more than 10 hours.

 To cancel the set programming press and hold down the value increase  and the value decrease  keys at the same time and then turn the oven off manually.





Programmed cooking

 Programmed cooking is the function which allows a cooking operation to be started at a set time and then ended after a specific length of time set by the user.

- Set the cooking time as described in the previous point "Timed cooking".
- Hold the menu key  down for 2 seconds.
- Press the menu key  again. The display will show the digits  and the text  in sequence, while the  symbol flashes (for example, the current time is 17:30)



- Use the  or  key to set the required minutes. (for example 1 hour)
- Press the menu key . The text  will appear on the display in sequence with the pre-set cooking duration added to the current time (for example, the cooking end time shown is 18:30).
- Press the  or  key to set the cooking end time. (for example, 19:30).

 Bear in mind that a few minutes for oven preheating must be added to the cooking time.

- Wait approx. 7 seconds without pressing any key in order for the function to activate. The current time and the  and  symbols appear on the display.
- Select a cooking temperature and function.
- At the end of cooking the heating elements will be deactivated. On the display, the symbol  turns off, the symbol  flashes and the buzzer sounds.



Use

10. Return the function and temperature knobs to **0**.
11. To turn off the buzzer just press any key of the programmer clock.
12. Press the  and  keys at the same time to reset the set program.





It is not possible to set a cooking time of more than 10 hours.



It is not possible to set a programmed cooking time of more than 24 hours.











After setting, hold the menu key  down for 2 seconds to display the cooking time remaining. Press the menu key  again. The display shows the text  and the remaining cooking time in sequence.

Minute minder timer



The minute minder timer does not stop the cooking operation but rather informs the user when the set time has run out.

The minute minder timer can be activated at any time.



1. Keep the clock key  pressed for per a few seconds. The display shows the figures  and the symbol  flashing between the hours and minutes.
 2. Use the value increase  and value decrease  keys to set the number of minutes required.
 3. Wait approx. 5 seconds without pressing any key to finish setting the minute minder. The current time and the symbols  and  appear on the display.
- A buzzer will sound when the set time is reached.
4. Press the value decrease key  to turn the buzzer off.





The minute minder timer can be set from 1 minute to a maximum of 23 hours and 59 minutes.



Modifying the set data





1. Press the clock key .
2. Use the value increase  and value decrease  keys to set the number of minutes required.

Deleting the set data

1. Press the clock key .
2. Hold down the value increase  and value decrease  keys at the same time.
3. Then switch off the oven manually if cooking is in progress.

Selecting the buzzer

The buzzer can have 3 tones.

1. Hold down the value increase  and value decrease  keys at the same time.
2. Press the clock key .
3. Press the value decrease key  to select a different buzzer tone.



Use

Cooking information table

Food	Weight (Kg)	Function	Runner position from the bottom	Temperature (°C)	Time (minutes)	
Lasagne	3 - 4	Convection	1	220 - 230	45 - 50	
Pasta bake	3 - 4	Convection	1	220 - 230	45 - 50	
Roast veal	2	Fan assisted/Fan forced	2	180 - 190	90 - 100	
Pork	2	Fan assisted/Fan forced	2	180 - 190	70 - 80	
Sausages	1.5	Fan grill	4	MAX	15	
Roast beef	1	Fan assisted/Fan forced	2	200	40 - 45	
Roast rabbit	1.5	Fan forced	2	180 - 190	70 - 80	
Turkey breast	3	Fan assisted/Fan forced	2	180 - 190	110 - 120	
Roast pork neck	2 - 3	Fan assisted/Fan forced	2	180 - 190	170 - 180	
Roast chicken	1.2	Fan assisted/Fan forced	2	180 - 190	65 - 70	
					1st surface	2nd surface
Pork chops	1.5	Fan grill	4	MAX	15	5
Spare ribs	1.5	Fan grill	4	MAX	10	10
Bacon	0.7	Grill	5	MAX	7	8
Pork fillet	1.5	Fan grill	4	MAX	10	5
Beef fillet	1	Grill	5	MAX	10	7
Salmon trout	1.2	Fan assisted/Fan forced	2	150 - 160	35 - 40	
Delicate fish	1.5	Fan assisted/Fan forced	2	160	60 - 65	
Flounder	1.5	Fan assisted/Fan forced	2	160	45 - 50	
Pizza	1	Fan assisted/Fan forced	2	MAX	8 - 9	
Bread	1	Fan forced	2	190 - 200	25 - 30	
Focaccia	1	Fan assisted/Fan forced	2	180 - 190	20 - 25	
Ring cake	1	Fan forced	2	160	55 - 60	
Jam tart	1	Fan forced	2	160	35 - 40	
Ricotta cake	1	Fan forced	2	160 - 170	55 - 60	
Jam tarts	1	Fan assisted/Fan forced	2	160	20 - 25	
Paradise cake	1.2	Fan forced	2	160	55 - 60	
Profiteroles	1.2	Fan assisted/Fan forced	2	180	80 - 90	
Sponge cake	1	Fan forced	2	150 - 160	55 - 60	
Rice pudding	1	Fan assisted/Fan forced	2	160	55 - 60	
Brioches	0.6	Fan forced	2	160	30 - 35	

The times indicated in the table do not include preheating times and are provided as a guide only.



4 Cleaning and maintenance

Instructions



Improper use Risk of damage to surfaces

- Do not use steam jets to clean the appliance.
- Do not use cleaning products containing chlorine, ammonia or bleach on steel parts or parts with metallic finishes on the surface (e.g. anodizing, nickel- or chromium-plating).
- Do not use abrasive or corrosive detergents (e.g. scouring powders, stain removers and metallic sponges) on glass parts.
- Do not use rough or abrasive materials or sharp metal scrapers.
- Do not wash the removable components such as the cooktop grids, flame-spreader crowns and burner caps in a dishwasher.

4.1 Cleaning the appliance



We recommend the use of cleaning products distributed by the manufacturer.

Recommendations for cleaning the cooktop

To keep the surfaces in good condition, they should be cleaned regularly after use. Let them cool first.

Cleaning the cooktop

1. Pour some non-abrasive detergent on a damp cloth and wipe down the surfaces.
2. Rinse thoroughly.
3. Dry with a soft cloth or a microfibre cloth.

Cleaning the cooktop grids, flame-spreader crowns and burner caps

1. Remove the components from the cooktop.
2. Clean them with warm water and non-abrasive detergent. Make sure to remove any encrustations.
3. Dry thoroughly with a soft cloth or a microfibre cloth.
4. Replace the components on the cooktop.



Continuous contact between the grids and the flame can cause modifications to the enamel over time in those parts exposed to heat. This is a completely natural phenomenon which has no effect on the operation of this component.



Cleaning and maintenance

Cleaning the igniters and thermocouples

- If necessary, clean the igniters and thermocouples with a damp cloth.
- If there is any dry residue, remove it with a toothpick or needle.

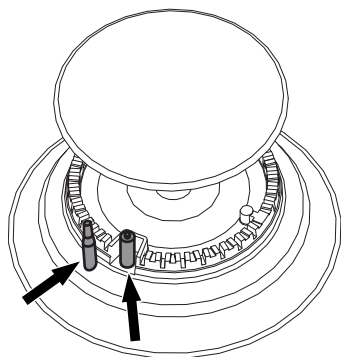

Recommendations for cleaning the oven cavity

For the best oven upkeep, clean it regularly after having allowed it to cool.

Avoid letting food residue dry inside the oven cavity, as this could damage the enamel.

Take out all removable parts before cleaning.

For easier cleaning, we recommend removing:

- The door
- The rack/tray support frames
- The oven seal.



In the event you are using specific cleaning products, we recommend running the oven at maximum temperature for 15-20 minutes in order to eliminate any residue.

4.2 Removing the door

For easier cleaning, the door can be removed and placed on a tea towel.

To remove the door proceed as follows:

1. Open the door completely and insert two pins into the holes on the hinges indicated in the figure.

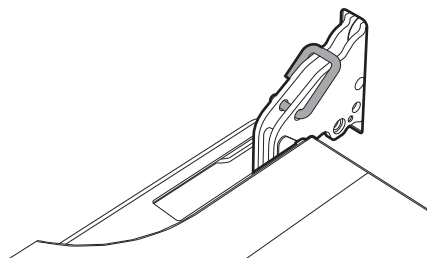

2. Grasp the door on both sides with both hands, lift it forming an angle of around 30° and remove it.

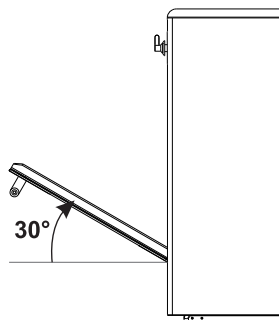



3. To reassemble the door, put the hinges in the relevant slots in the oven, making sure that grooved sections **A** are resting completely in the slots. Lower the door and once it is in place remove the pins from the holes in the hinges.

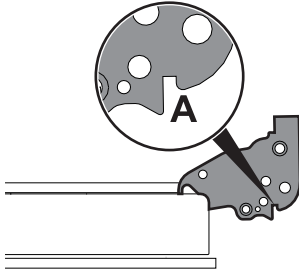

4.3 Cleaning the door glazing

The glass in the door should always be kept thoroughly clean. Use absorbent kitchen roll. In case of stubborn dirt, wash with a damp sponge and an ordinary detergent.

4.4 Removing the internal glass panes

For easier cleaning the door internal glass panes can be disassembled.

1. Remove the internal glass pane by pulling the rear part gently upwards, following the movement indicated by the arrows (1).
2. Then, pull the front part upwards (2). In this way, the 4 pins attached to the glass detach from their housings in the oven door.

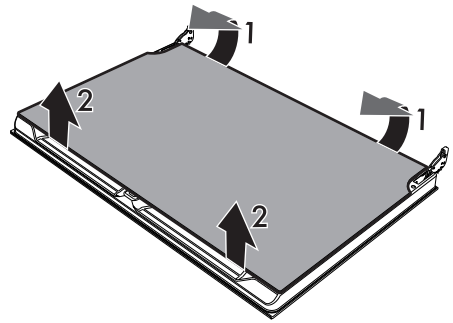

3. Some models have an intermediate glass pane. Remove the intermediate glass pane by lifting it upwards.

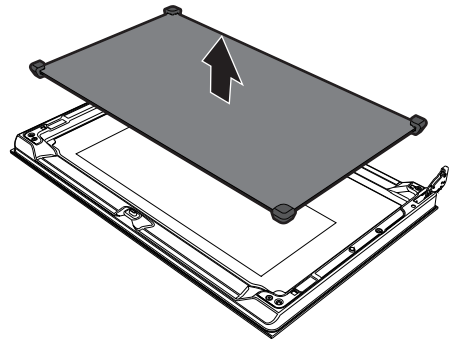



Cleaning and maintenance

4. Clean the external glass pane and the panes previously removed. Use absorbent kitchen roll. In case of stubborn dirt, wash with a damp sponge and neutral detergent.

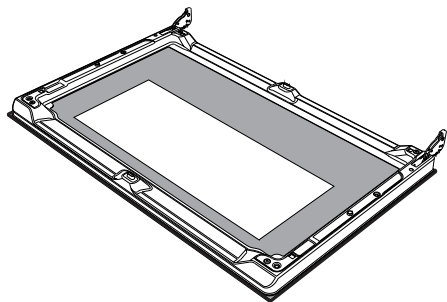

5. Refit the panes in the reverse order in which they were removed.
6. Reposition the internal glass pane. Take care to centre and insert the 4 pins into their housings in the oven door by applying slight pressure.

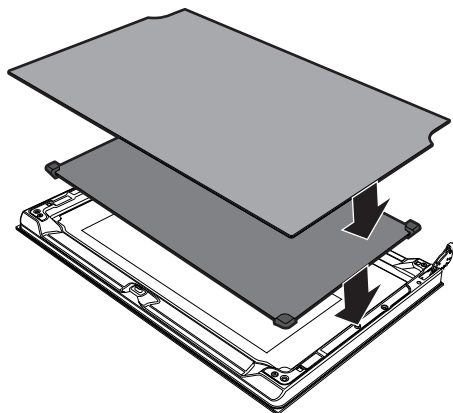

Removing racks/trays support frames

Removing the guide frames enables the sides to be cleaned more easily. This operation should be performed each time the automatic cleaning cycle is used (on some models only).

To remove the guide frames: Pull the frame towards the inside of the oven to unhook it from its groove **A**, then slide it out of the seats **B** at the back.

When cleaning is complete, repeat the above procedures to put the guide frames back in.

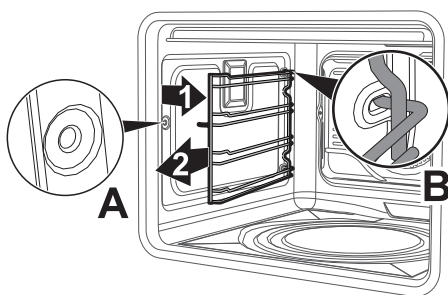



4.5 Vapour Clean



Vapour Clean is an assisted cleaning procedure which facilitates the removal of dirt. Thanks to this process, it is possible to clean the inside of the oven very easily. The dirt residues are softened by the heat and water vapour for easier removal at a later stage.



Improper use
Risk of damage to surfaces

- Remove any food residues or large spills from previous cooking operations from the inside of the oven.
- Carry out assisted oven cleaning operations only when the oven is cold.

Preliminary operations

Before starting the Vapour Clean function:

- Completely remove all accessories from inside the oven.

- Pour approximately 40 cc of water into the tray. Make sure it does not overflow out of the cavity.

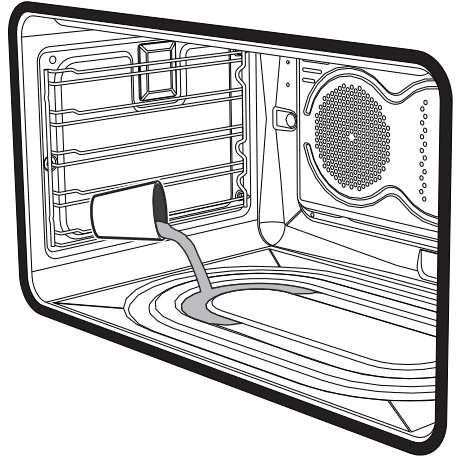

- Spray a water and washing up liquid solution inside the oven using a spray nozzle. Direct the spray against the side walls, upwards, downwards and towards the deflector.

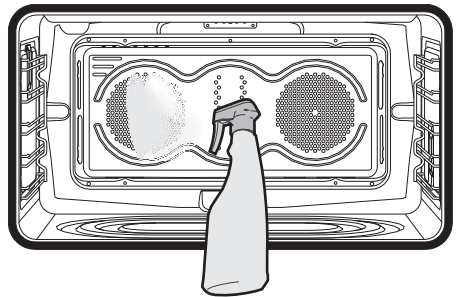

- Close the door.





We recommend spraying approx. 20 times at the most.



Cleaning and maintenance

Vapour Clean setting

1. Turn the function knob to the symbol  and the temperature knob to the symbol .
2. Set a cooking time of 18 minutes using the programmer clock.

The Vapour Clean cycle starts a few seconds after the last press on the programmer clock keys.

3. At the end of the Vapour Clean cycle, the timer will deactivate the oven heating elements, the buzzer will start to sound and the numbers on the programmer clock dial will flash.

End of the Vapour Clean cycle

4. Open the door and wipe away the less stubborn dirt with a microfibre cloth.
5. Use an anti-scratch sponge with brass filaments on tougher encrustations.
6. In case of grease residues use specific oven cleaning products.
7. Remove the water left inside the oven.

For improved hygiene and to avoid food being affected by any unpleasant odours, we recommend that the oven is dried using a fan assisted function at 160°C for approximately 10 minutes.

4.6 Extraordinary maintenance

Removing and installing the oven seal

To remove the oven seal:

- Unhook the clips in the 4 corners and in the centre, then pull the oven seal.

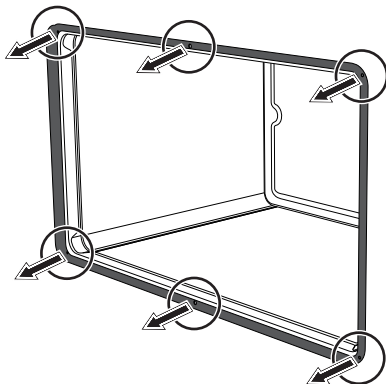

To install the oven seal:

- Hook the clips in the 4 corners and in the centre onto the oven seal.

Oven seal maintenance tips

The seal should be soft and elastic.

To keep the oven seal clean, use a non-abrasive sponge and lukewarm water to wash it.



We recommend wearing rubber gloves for these operations.



For easier manual cleaning of the parts difficult to reach, we recommend removing the door.



Replacing the oven light bulb



Live parts
Danger of electrocution

- Unplug the appliance.



The oven is fitted with a 40W light bulb.

1. Completely remove all accessories from inside the oven.
2. Remove the racks/trays support frames.
3. Remove the bulb cover using a tool (e.g. a screwdriver).



Pay attention not to scratch the oven cavity enamel.

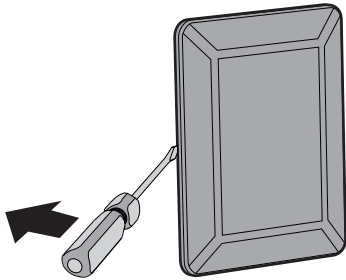

4. Slide out and remove the light bulb.

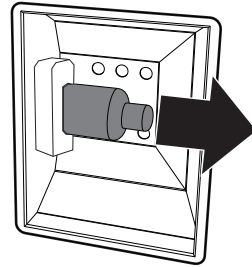

Do not touch the halogen light bulb directly with your fingers, but wrap it in insulating material.

5. Fit the new light bulb.
6. Refit the cover. Ensure the moulded part of the glass (A) is facing the door.

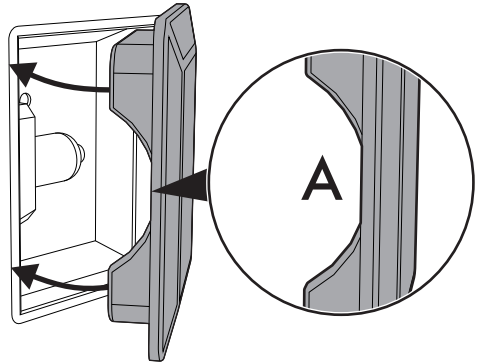

7. Press the cover completely down so that it attaches perfectly to the bulb support.



Cleaning and maintenance

What to do if...

The appliance does not work.

- The circuit breaker is faulty: look in the fuse box and check that the circuit breaker is in working order.
- Power cut: check whether the kitchen light works.

The gas burner does not ignite.

- Power cut or damp ignition plugs: light the gas burner with a gas lighter or a match.

The oven does not heat up.

- Faulty fuse: check and, if required, replace the circuit breaker.
- The function knob has not been set: set the function knob.

All dishes that are prepared in the oven burn within an extremely short period of time.

- Faulty thermostat: call the Authorised Assistance Centres.

The door panel steams up when the oven is hot.

- Normal occurrence caused by the difference in temperature: this has no effect on oven performance.



5 Installation

5.1 Minimum clearance to combustible surfaces

Freestanding cooker

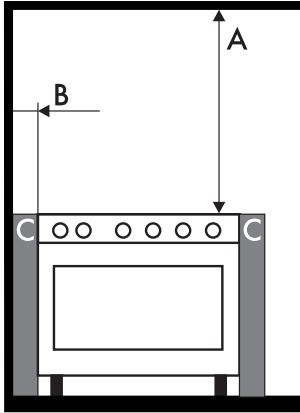

A 600 mm (Overhead) measured from the highest part of the highest burner and 750 mm for an exhaust fan.

B 200 mm (Vertical combustible surface) measured from the edge of the nearest burner.

C 10 mm (Horizontal combustible surface) below the hob.



Refer to AS/NZS 5601 (Protection of a combustible surface) if the above minimum clearances cannot be achieved.



The appliance connection point shall be accessible with the appliance installed.



Maximum height of the top pan support with respect to the surface that supports the appliance is 912mm.

5.2 Gas connection



Gas leak
Danger of explosion

- After carrying out any operation, check that the tightening torque of gas connections is between 10 Nm and 15 Nm.
- If required, use a pressure regulator that complies with current regulations.
- At the end of the installation, check for any leaks with a soapy solution, never with a flame.

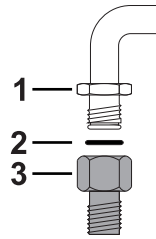

Carefully screw the connector **3** to the appliance's gas connector **1** (1/2" thread ISO 228-1), placing the supplied seal **2** between them. This appliance must be installed by an authorised person in accordance with this instruction manual, AS/NZS 5601.1 – Gas installations (installation and pipe sizing), local gas fitting regulations, local electrical regulations, local health regulations, Building Code of Australia and any other government authority.



Installation

This appliance is suitable for connection with rigid pipe or flexible hose. The isolating manual shut-off valve connection point must be accessible when the appliance is installed.

Flexible hose assembly must be certified to AS/NZS 1869 class B or D, be of appropriate internal diameter for the total gas consumption (10mm), be kept as short as possible (not exceeding 1200mm), must not be in contact with the floor or any hot surface or sharp surface. The hose assembly must not be subject to strain, abrasion, kinking, deformation, contact with any other appliance or accidental contact with oven flue outlet of an under bench oven.

Gas leakage and operation of the appliance must be tested by the installer before leaving. Check burner flames are blue in colour, stable and completely ignite at both high and low flame settings with no appreciable yellow tipping, carbon deposition, lifting, floating, lighting back or objectionable odour. Test burners individually and in combination, When satisfied with the operation of the cooker, please instruct the user on the correct method of operation

Natural Gas: the regulator must be fitted to the appliance inlet connection. Gas pressure must be adjusted to 1.0 kPa when approximately 50% of the burners are on high flame, the appliance test point is located on the regulator.

Universal LPG: gas pressure must be checked to confirm the appliance operating pressure is 2.75 kPa.

1. Disconnect power.
2. Light the auxiliary burner and set to high flame. Ensure all other burners are off.
3. Zero manometer, then apply flexible tubing to seal over the Rapid burner injector, hold securely in place and check the gas pressure by pressing in the corresponding burner control knob in, then turning to high flame position.
4. If the pressure is 2.75 kPa, reassemble the burner and perform the final checks as per this instruction manual.
5. If the pressure is not 2.75 kPa, disconnect the appliance and check/adjust/replace the LPG cylinder regulator(s) as appropriate in accordance with AS/NZS 5601.

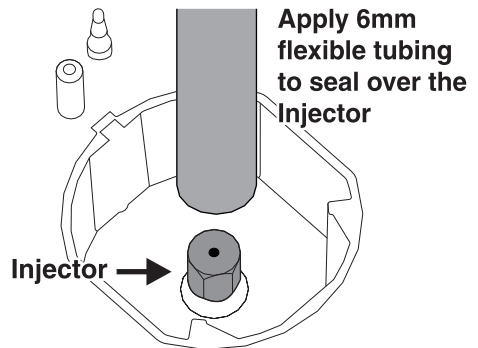

Patent 2015101170. For enquires contact Gas Approval Consulting Pty Ltd Smeg licence 037 for GSCS20265



Room ventilation

The room containing the appliance should have a permanent air supply in accordance with the standards in force. The room where the appliance is installed must have enough air flow needed for the regular combustion of gas and the necessary air change in the room itself. The cooktop shall be installed in rooms with natural ventilation, as required by Standards regulations AS/NZS5601.

Combustion gas discharge

Combustion gases may be discharged by means of hoods connected to a flue with reliable natural draught, or a fan extraction system. An effective extraction system requires careful design by an authorised specialist, and must comply with the regulation distances and positions. After installation, the engineer must issue a certificate of compliance.

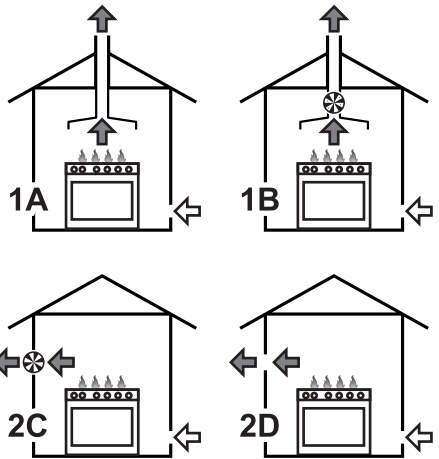

1 Extraction using a hood.

2 Extraction without a hood.

A Single natural draught chimney.

B Single chimney with extractor fan.

C Directly outdoors with wall- or window-mounted extractor fan.

D Directly outdoors through wall.





Installation

5.3 Adaptation to different types of gas

In case of operation with other types of gas, the burner nozzles must be changed and the minimum flame adjusted on the gas cocks.

Replacing nozzles

1. Remove the pan stands, burner caps and flame-spreader crowns to access the burner casings.
2. Replace the nozzles using a 7 mm socket wrench according to the gas to use (see "Burner and nozzle characteristics table").

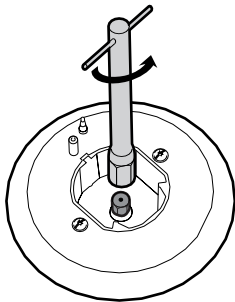

3. Replace the burners in the correct position.

Adjusting the minimum setting for natural or city gas

Light the burner and turn it to the minimum position. Extract the gas cock knob and turn the adjustment screw next to the cock rod (depending on the model) until the correct minimum flame is achieved.

Refit the knob and verify that the burner flame is stable.

Turn the knob rapidly from the maximum to the minimum setting: the flame should not go out. Repeat the operation on all gas cocks.

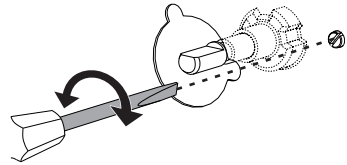
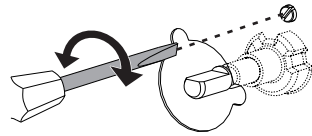

Adjusting the minimum setting for LPG

Tighten the screw located at the side of the cock rod clockwise all the way.



Following adjustment to a gas other than the one originally set in the factory, replace the gas setting label fixed to the appliance with the one corresponding to the new gas. The label is inserted inside the nozzle pack (where present).

Lubrication of gas cocks

Over time the gas cocks may become difficult to turn and get blocked. Clean them internally and replace the lubrication grease.



The greasing of the gas cocks should be performed by authorised persons.



Burner and nozzle characteristics table

1 ULPG 2.75 kPa	AUX	SR	R	UR
Nominal gas consumption (MJ/h)	3.9	6.3	10.8	15
Injector (1/100 mm)	54	68	88	105
2 NG 1.0 kPa	AUX	SR	R	UR
Nominal gas consumption (MJ/h)	3.9	7.5	12	14.4
Injector (1/100 mm)	90	120	155	175

Overall dimensions

Location of gas and electrical connection points.

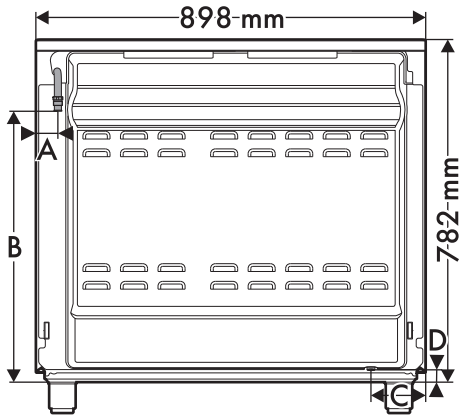

A	46 mm
B	660 mm
C	124 mm
D	41 mm

5.4 Positioning



**Heavy appliance
Danger of crush injuries**

- Place the appliance into the piece of furniture with the aid of a second person.



**Pressure on the open door
Risk of damages to the appliance**

- When positioning the appliance during installation, do not use the door handle to lift up or move this appliance.
- Never use the oven door to lever the appliance into place when fitting.
- Avoid exerting too much pressure on the oven door when open.



**Heat production during appliance operation
Risk of fire**

- Veneers, adhesives or plastic coatings on adjacent furniture should be temperature-resistant (no less than 90°C).



Installation

General information

This appliance may be installed next to walls, one of which must be higher than the worktop, at a minimum distance of 50 mm from the side of the appliance, as shown in figures **A** and **C** relative to the installation classes.

Any wall units positioned above the worktop must be at a minimum distance of at least 600 mm. If a hood is installed above the cooktop, refer to the hood instruction manual to ensure the correct clearance is left.

Depending on the type of installation, this appliance belongs to classes:

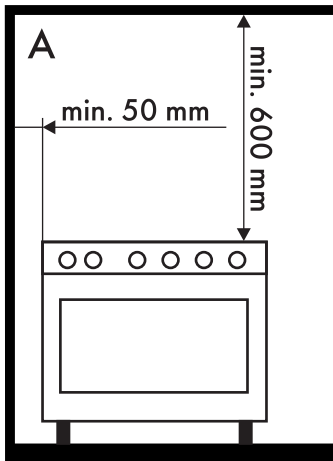

A - Class 1 (Free-standing appliance)

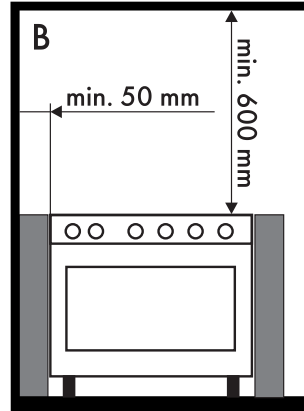

B - Class 2 subclass 1 (Built-in appliance)

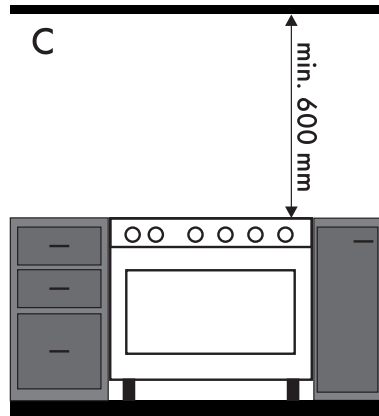

C - Class 2 subclass 1 (Built-in appliance)



The appliance must be installed by authorised persons and according to the regulations in force.



If the appliance is installed on a raised platform, secure it using suitable fastening systems. **DO NOT MODIFY THIS APPLIANCE.**



Positioning and levelling



**Heavy appliance
Risk of damage to the appliance**

- Insert the front feet first and then the rear ones.
- After making the gas and electrical connections, screw on the four feet supplied with the appliance.

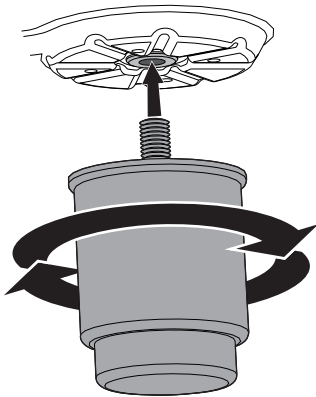

The appliance must sit level on the floor to ensure stability.

- Screw or unscrew the bottom part of the foot until the appliance is stable and level on the floor.

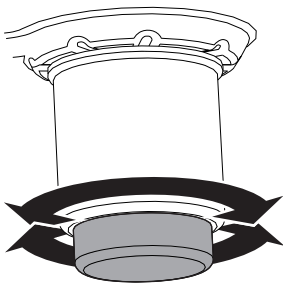

Fastening to the wall



The anti-tip devices must be installed in order to prevent the appliance tipping over.

1. Screw the wall fastening plate to the rear of the appliance.

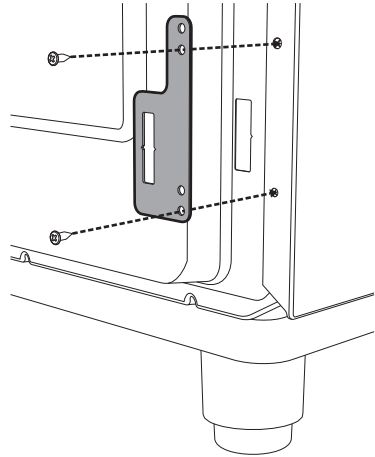

2. Adjust the height of the 4 feet.

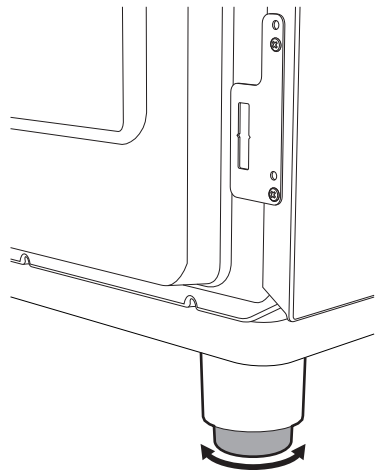



Installation

3. Assemble the fastening bracket.

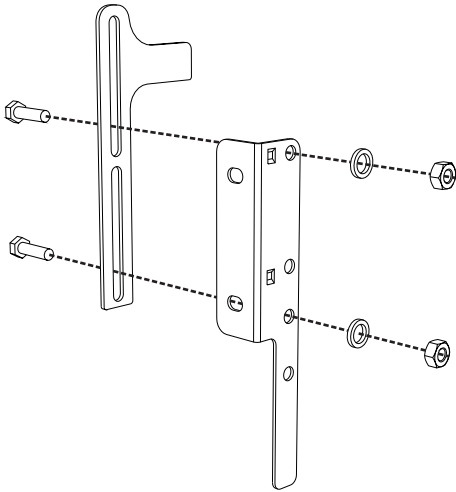

5. Align the base of the fastening bracket with the ground and tighten the screws to fix the measurements.

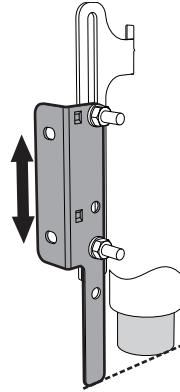

4. Align the base of the hook on the fastening bracket with the base of the slot on the wall fastening plate.

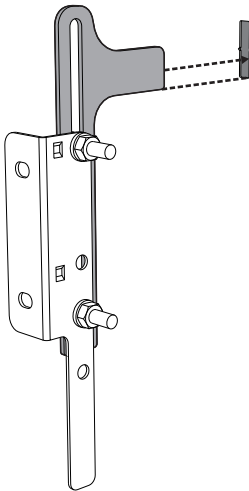

6. Use 50 mm for the distance from the side of the appliance to the bracket holes.

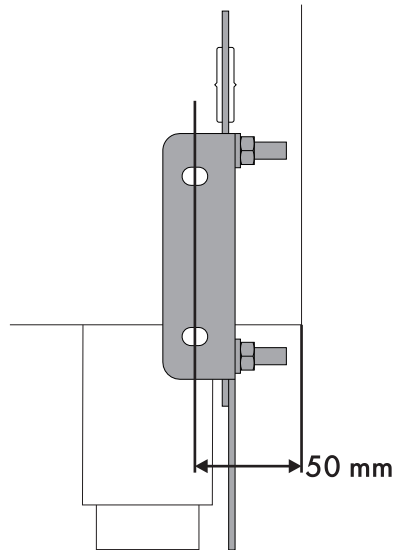



7. Move the bracket onto the wall and mark the position of the holes to be drilled in the wall.

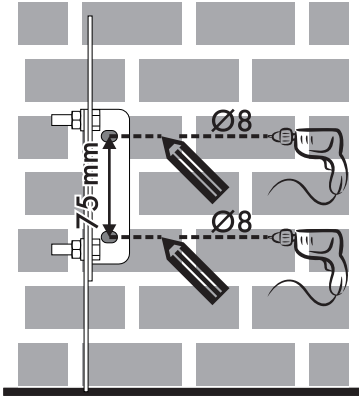

8. After drilling the holes in the wall, use wall plugs and screws to fasten the bracket to the wall.
9. Push the cooker towards the wall, and at the same time, insert the bracket in the plate fastened to the rear of the appliance.

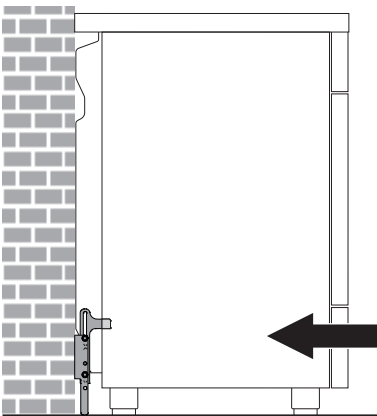

Wall fixing

1. Turn the screw placed behind the cooktop near the gas connection.

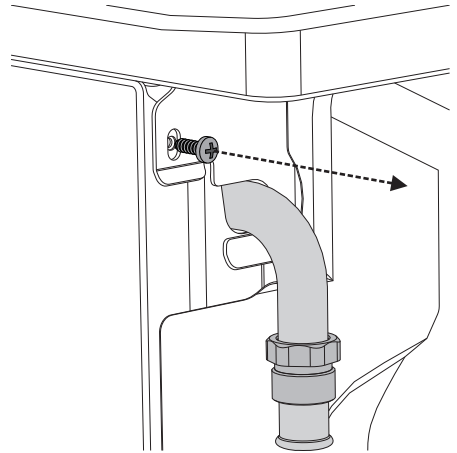

2. Attach the chain to the cooker with the screw just removed.

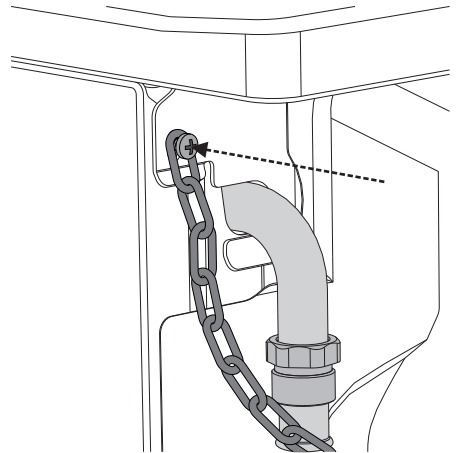

3. Stretch it out horizontally so that the other end of the chain touches the wall.



Installation

4. Mark the wall in the position where the hole is to be drilled.

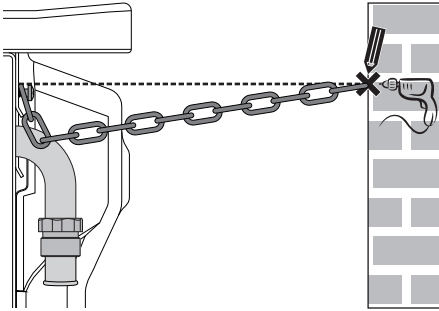

5. Drill the hole and insert a wall plug.

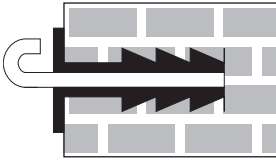

6. Attach the chain and push the appliance to the wall.

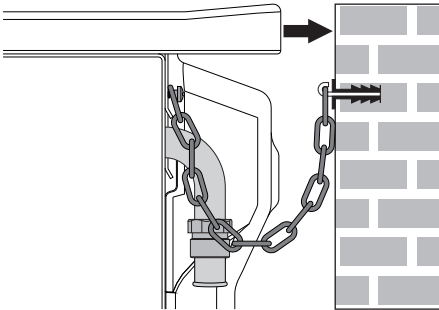

 The chain length must be as short as practicable to avoid appliance tilting forward and also diagonal to avoid appliance moving sideways.

Assembling the upstand

i The upstand provided is an integral part of the product. It must be fastened to the appliance prior to installation.

The upstand must always be positioned and secured correctly on the appliance.

1. Unscrew the 2 nuts **B** on the back of the worktop.
2. Position the upstand above the worktop, taking care to align the pins **C** with the holes **D**.
3. Secure the upstand to the worktop by tightening the screws **A**.

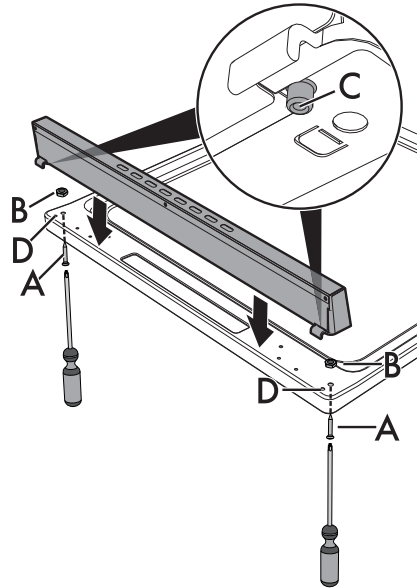



Assembling the toe skirt

The toe skirt must always be positioned and secured correctly on the appliance.

1. Use a screwdriver to remove the highlighted screws.

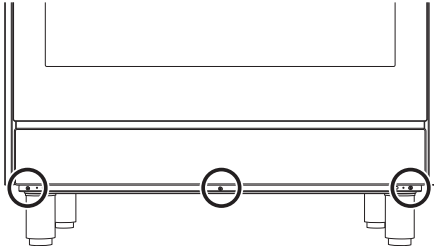

2. Align the toe skirt with the corresponding holes on the appliance.
3. Fasten the toe skirt using the screws that were previously removed.

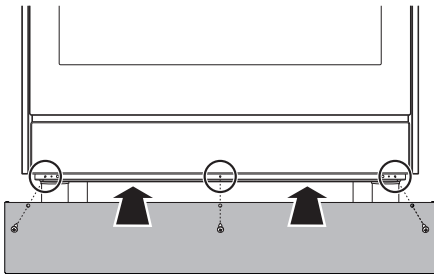

5.5 Electrical connection



Power voltage

Danger of electrocution

- Have the electrical connection performed by authorised technical personnel.
- Use personal protective equipment.
- The appliance must be connected to earth in compliance with electrical system safety standards.
- Disconnect the mains supply.
- Do not pull the cable to remove the plug.
- Use cables withstanding a temperature of at least 90°C.
- The tightening torque of the screws of the terminal board conductors must be 1.5 - 2 Nm.

General information

Check the grid characteristics against the data indicated on the plate.

The identification plate bearing the technical data, serial number and brand name is visibly positioned on the appliance.

Do not remove this plate for any reason.

Perform the ground connection using a wire that is 20 mm longer than the other wire



Installation

The appliance can work in the following modes:

- **220-240 V 1N~**

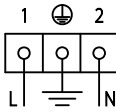

use a **3 x 1,5 mm² three-core** cable.

i The values indicated above refer to the cross-section of the internal conductor.

i The aforementioned power cables are sized taking into account the coincidence factor (in compliance with standard EN 60335-2-6).

Fixed connection

Fit the power line with an all-pole circuit breaker with a contact separation distance sufficient to provide complete disconnection in category III overvoltage conditions, pursuant to installation regulations. The disconnection incorporated in the fixed wiring must be compliant to AS/NZS 3000 regulations.

Connection with plug and socket

Make sure that the plug and socket are of the same type.

Avoid use of adapters and shunts as these could cause overheating and a risk of burns.

5.6 For the installer

- The plug must remain accessible after the installation is complete. Do not kink or trap the mains connection cable.
- The appliance must be fitted according to the installation diagrams.
- Do not attempt to turn or stress the threaded elbow on the manifold. You risk damage to this part of the appliance which may void the manufacturer's warranty.
- Before leaving check all connections for gas leaks with soap and water. DO NOT use a naked flame for detecting leaks.
- Ignite all burners individually and concurrently to ensure correct operation of the gas valves, burner and ignition.
- Turn the gas knobs to the low position and observe stability of the flame for each burner individually and all together.
- In case the appliance fails to operate correctly after all checks have been carried out, refer to the Authorised Assistance Centre in your area.
- When satisfied with the appliance, please instruct the user on the correct method of operation.



91477A036/A